

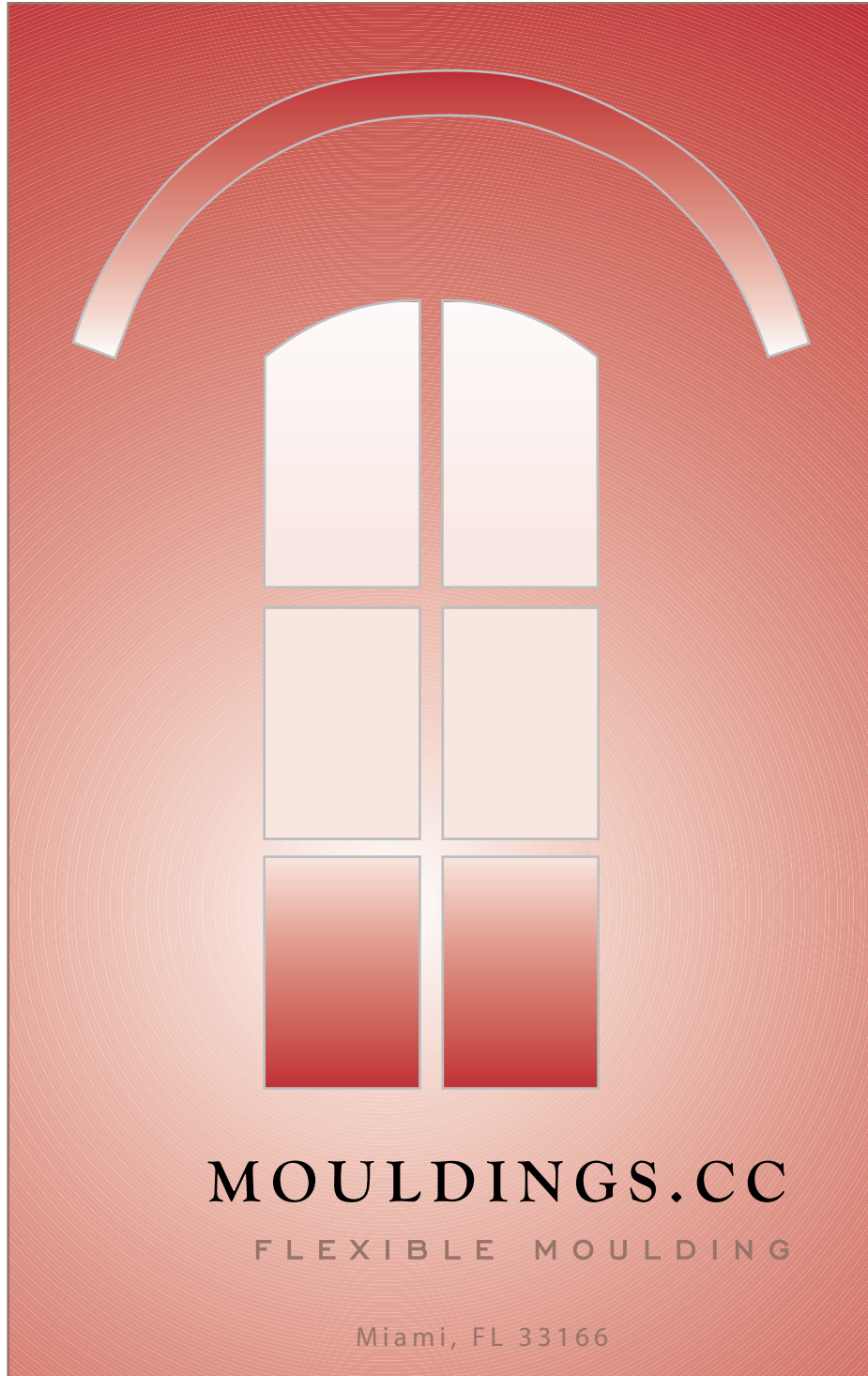

Miami, FL 33166  
1-888-883-3113  
FAX 1-305-675-3738  
[www.mouldings.cc](http://www.mouldings.cc)

# *Flexible* MOULDINGS



S E L E C T I O N   G U I D E

FLEXIBLE MOULDING

Mouldings.cc has maintained a leadership role by helping artisans create their vision through moulding replications.

Our Made-To-Match process (MTM), gives Mouldings.cc the unique opportunity to match any style our customers wish to replicate. Through this process, our skills and technology allow us to reproduce the most intricate and minimal moulding designs provided for replication.

By working with our skilled order specialists, we can fashion radius pieces to match your original samples. Typically, we create 12 ft. molds of the samples that you send. We replicate the moulding to fit your templates and specifications. We can ship both straight and curved mouldings to fit your project needs.

Because we give each order special attention, we have a reputation of exceeding industry delivery standards. We stock many profiles so that we can provide accelerated delivery. Many of these items are marked with an "S" in this guide; however, we have many more designs that may fit your ideas. We can search our inventory of mouldings using a small moulding piece or your tracing as reference. No order is too large or too small. Call us.

1-888-883-3113

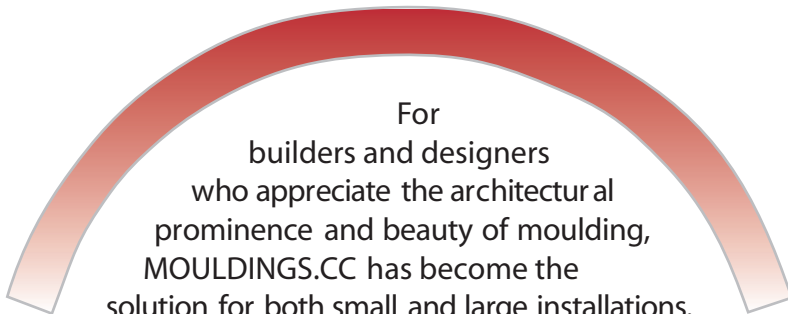

For  
builders and designers  
who appreciate the architectural  
prominence and beauty of moulding,  
MOULDINGS.CC has become the  
solution for both small and large installations.  
Whether the need is one uniquely designed  
style or hundreds of feet with optimum  
consistency, we satisfy the demand with quality  
assured mouldings. Each piece is individually  
inspected to provide the highest quality control.  
Here are features that make Mouldings.cc  
of the most desired moulding products in  
the building industry.

- MATERIALS  
Polyurethane Composite Material
- WARRANTY  
Lifetime warranty for products
- MOULDING SIZES  
Same sizes as wood
- FLEXIBILITY  
6 standard sizes cover 1/8 to 7/0 Half Round
- FINISHING  
Accepts paint or stain
- MACHINING  
Use same tools as wood
- STRENGTH  
Heat - Minimal Effect  
Cold - Minimal Effect
- VALUE  
Low cost with excellent performance

We are available to provide any ordering information or answer any questions Monday through Friday. You may order by calling 1-888-883-3113 or sending faxes to 1-305-675-3738.

We ship all orders prepaid and delivery of Stock Items is made within one or two days for UPS shipments. We schedule regular deliveries with common carriers for larger orders.

# Ordering Information

We are always happy to help you with any specification questions before you enter your order.

These are some commonly requested configurations and typical information we need for production.

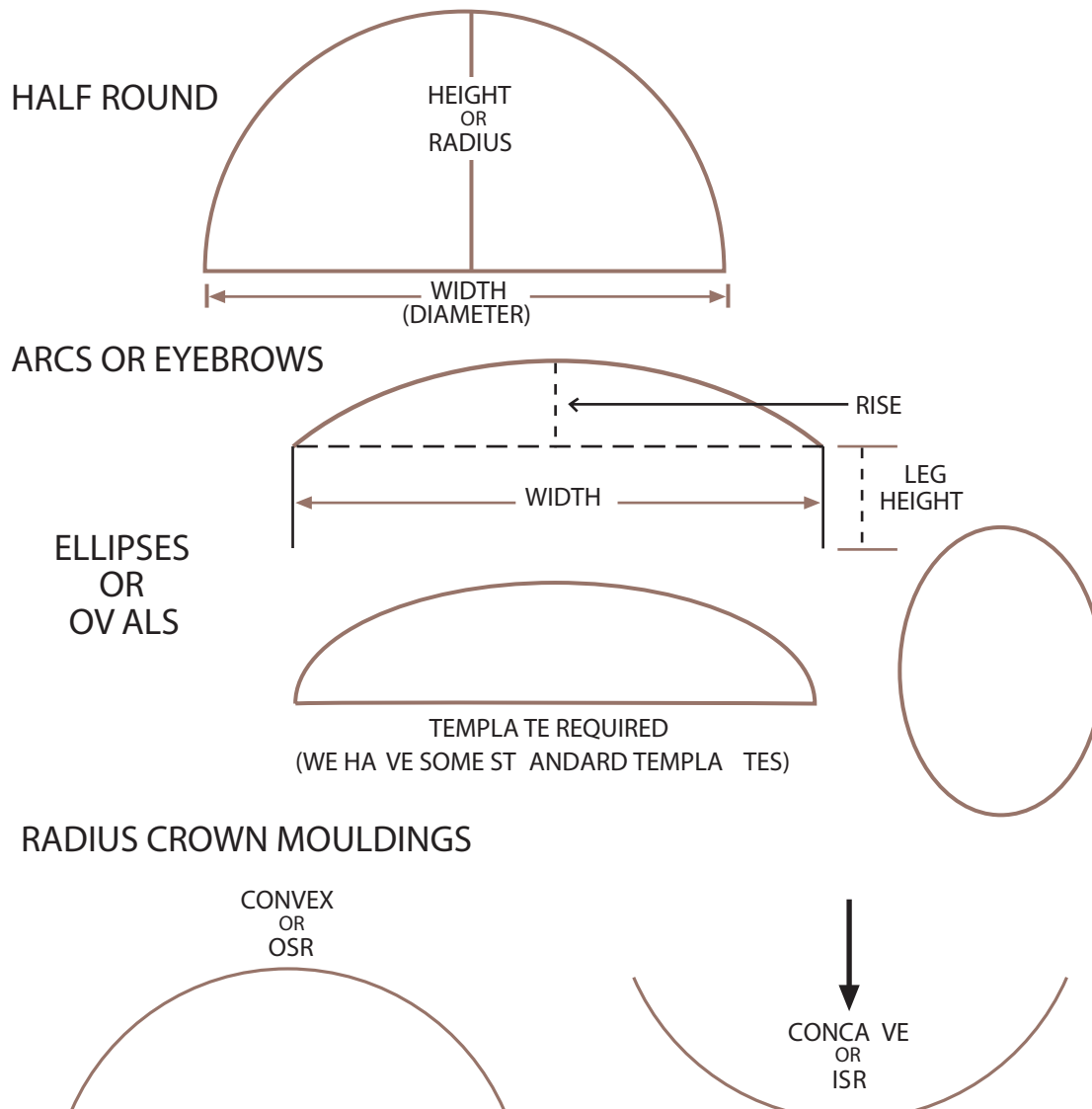

Please provide a radius dimension of wall or width of unit and how much the wall or ceiling recesses (ISR) or projects (OSR).

NOTE: Curved ceilings or dormers (Barrel Vaults) are convex or OSR applications. Please specify at time of order.

IMPORTANT: Straight (lineal, non pre-radiused) pieces will only be suitable for certain applications. Please call us with any information to insure appropriate material is ordered and provided.



The drawings shown in this book are a reference and may be different than actual mouldings produced.

Installation and care instructions on page 4.

"S" items are in stock



# MOULDINGS.CC

## INSTALLATION

### USE:

This flexible moulding is designed for interior and exterior use. This product is stable and will not absorb moisture. However, the use of a paint or gel stain and sealer is recommended for all applications.

### MACHINING

Conventional woodworking tools can be used with this material. Material can be cut, sanded and shaped with ease. Miter saws work well when trimming this material. As with all types of trim material, use care when marking and cutting.

### FASTENING

Always install moulding material in a relaxed position. Use construction or panel adhesive or mastic type glue continuously on back side and nails to secure moulding material in place until adhesive bonds.

- DO NOT use staples to fasten material.
- Keep nails to a minimum, no closer than 6" between nails.
- Do not nail closer than 3/8" from edge of moulding.

### CLEANING

Prior to finishing, clean the moulding by wiping with a cloth using soap and water, paint thinner or any mild solvent to clean any dirt or grease that may have accumulated during installation.

### PAINT & STAINING

All MOULDINGS.CC material is paint grade and most profiles have grain and can be stained. Inspect for grain or call for information on compatibility of staining. Staining of MOULDINGS.CC material requires the use of a gel type stain.

## LIFETIME WARRANTY

Mouldings.cc warrants that for the "lifetime" ownership, the MOULDINGS.CC moulding is free from defects in material and workmanship. "Lifetime" means as long as the original purchaser owns the structure to which the MOULDINGS.CC moulding has been properly attached. Mouldings.cc will repair or replace at its option any MOULDINGS.CC moulding that has failed as a result of defective material and workmanship. This remedy is the purchaser's exclusive remedy for breach of warranty hereunder.

THE FOREGOING WARRANTY IS IN LIEU OF ALL OTHER WARRANTIES, EXPRESSOR IMPLIED, INCLUDING BUT NOT LIMITED TO THE IMPLIED WARRANTIES OF MERCHANTABILITY AND FITNESS FOR A PARTICULAR PURPOSE.

At no time will Mouldings.cc be liable for more than the original purchase price of the moulding, nor will Mouldings.cc be liable for any special, incidental or consequential damages based upon breach of warranty, breach of contract, loss of profits, loss of savings or revenue, loss of use, the claims of third parties and injury to property. Some states do not allow limits on warranties or on remedies for breach in certain transactions. In such states, the limits in this paragraph and the preceding paragraph may not apply.

It shall remain the responsibility of the customer to insure that the moulding purchased is designed for their particular installation.

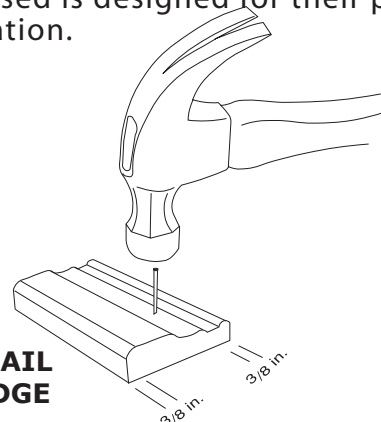

**TO AVOID DAMAGE, DO NOT NAIL CLOSER THAN 3/8 IN FROM EDGE**

# CASING

MOULDINGS.CC  
FLEXIBLE MOULDING

Many more profiles available, call 888-883-3113 \* Fax 305-675-3738

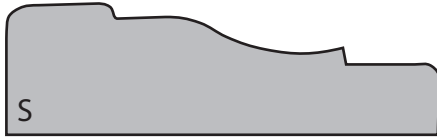

C M 356  
1<sup>1</sup>/<sub>16</sub> X 2<sup>1</sup>/<sub>4</sub> in.

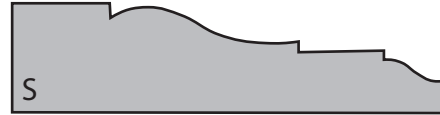

C M 366  
1<sup>1</sup>/<sub>16</sub> X 2<sup>1</sup>/<sub>4</sub> in.

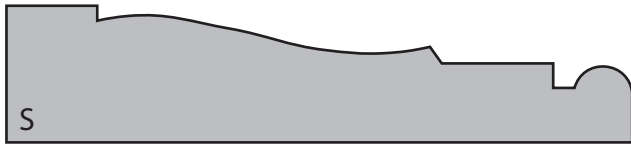

C M 445  
1<sup>1</sup>/<sub>16</sub> X 3<sup>1</sup>/<sub>4</sub> in.

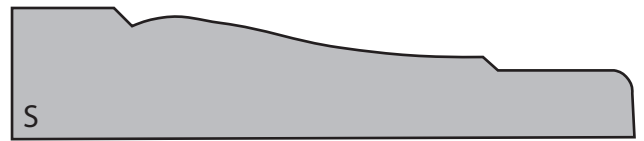

C M 444  
1<sup>1</sup>/<sub>16</sub> X 3<sup>1</sup>/<sub>4</sub> in.

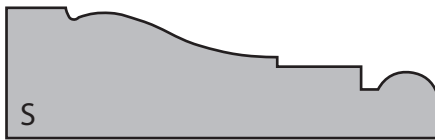

C M 376  
1<sup>1</sup>/<sub>16</sub> X 2<sup>1</sup>/<sub>4</sub> in.

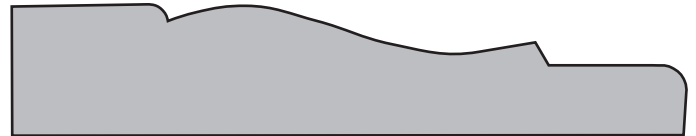

C M 444A  
1<sup>1</sup>/<sub>16</sub> X 3<sup>1</sup>/<sub>2</sub> in.

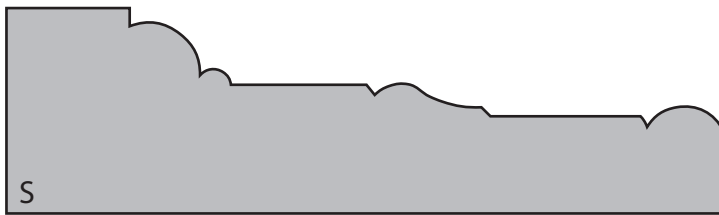

C M 470  
1<sup>1</sup>/<sub>16</sub> X 3<sup>11</sup>/<sub>16</sub> in.

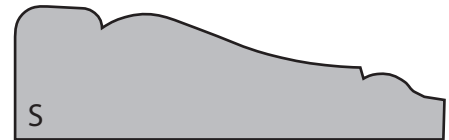

C M 442  
1<sup>1</sup>/<sub>16</sub> X 2<sup>1</sup>/<sub>4</sub> in.

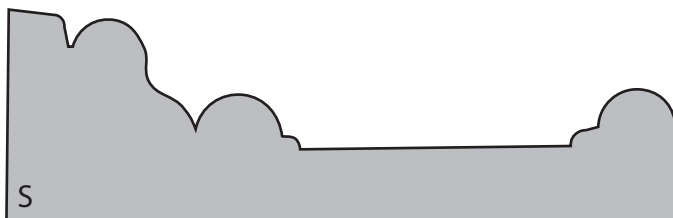

C M 1  
1<sup>1</sup>/<sub>16</sub> X 3<sup>1</sup>/<sub>2</sub> in.

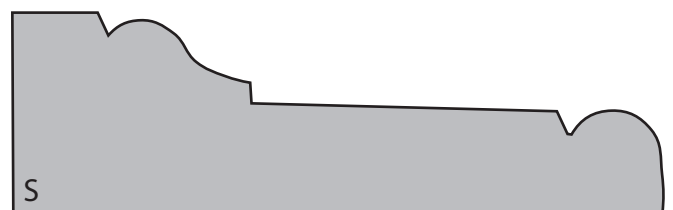

C M 97  
1<sup>1</sup>/<sub>16</sub> X 3<sup>1</sup>/<sub>2</sub> in.

Many more profiles available, call 888-883-3113 \* Fax 305-675-3738

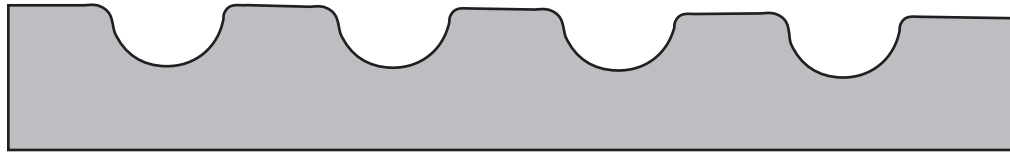

C NF525  
3/4 X 5 1/4 in.

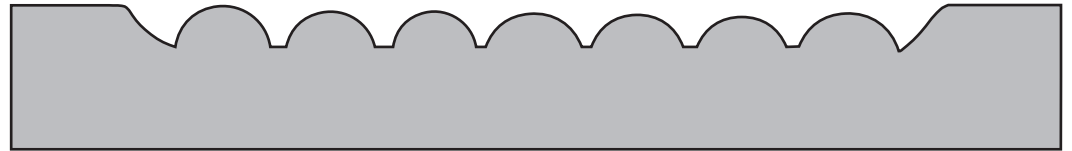

C606R  
1 1/16 X 5 1/2 in.

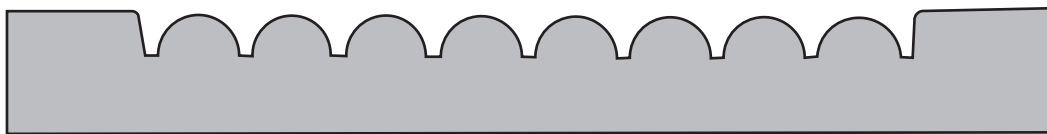

S M75  
3/4 X 5 1/2 in.



S M85  
3/4 X 5 1/4 in.



C606F  
1 1/16 X 5 1/2 in.



S M5806  
3/4 X 5 1/2 in.

Many more profiles available, call 888-883-3113 \* Fax 305-675-3738

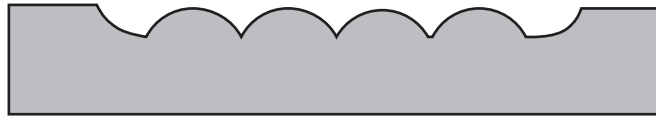

C600R  
1<sup>1</sup>/<sub>16</sub> X 3<sup>1</sup>/<sub>2</sub> in.



CM14R  
1<sup>1</sup>/<sub>16</sub> X 3<sup>1</sup>/<sub>4</sub> in.

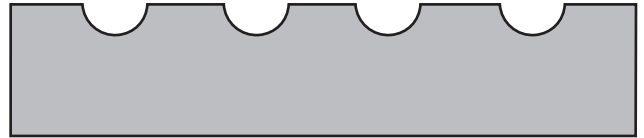

CM14F  
1<sup>1</sup>/<sub>16</sub> X 3<sup>1</sup>/<sub>4</sub> in.



PT338F  
5/8 X 3<sup>3</sup>/<sub>8</sub> in.



PT338R  
5/8 X 3<sup>3</sup>/<sub>8</sub> in.



CCC350  
3/4 X 3<sup>7</sup>/<sub>16</sub> in.



1002  
9/16 X 3<sup>9</sup>/<sub>16</sub> in.



1002M  
1/2 X 2<sup>1</sup>/<sub>4</sub> in.



CNF312  
3/4 X 3<sup>7</sup>/<sub>16</sub> in.

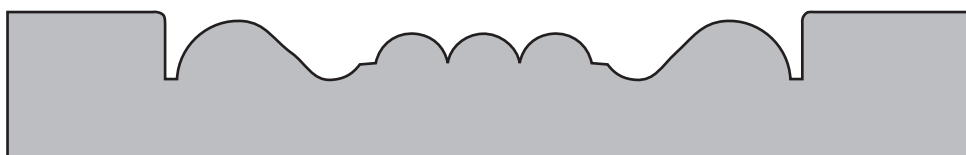

SM8  
3/4 X 5 in.

Many more profiles available, call 888-883-3113 \* Fax 305-675-3738



S M 12  
1<sup>5</sup>/<sub>16</sub> X 4<sup>1</sup>/<sub>2</sub> in.

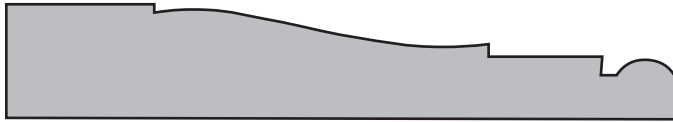

C M 445A  
1<sup>1</sup>/<sub>16</sub> X 3<sup>1</sup>/<sub>2</sub> in.

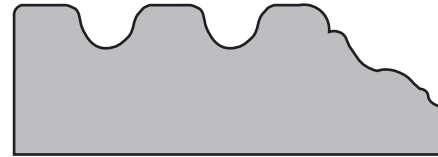

C FC 214, 3/4 X 2<sup>1</sup>/<sub>4</sub> in.  
Also Available:  
C FC 315, 3/4 X 3<sup>1</sup>/<sub>2</sub> in.  
C FC 425, 3/4 X 4<sup>1</sup>/<sub>4</sub> in.

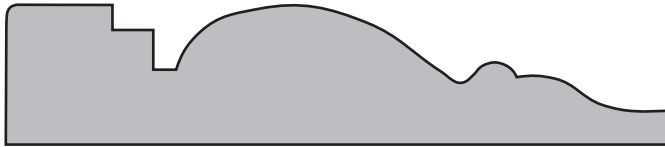

24112PCA  
3/4 X 3<sup>1</sup>/<sub>2</sub> in.



2814  
1<sup>1</sup>/<sub>4</sub> X 4<sup>5</sup>/<sub>8</sub> in.



C M 460  
1<sup>1</sup>/<sub>16</sub> X 3<sup>11</sup>/<sub>16</sub> in.

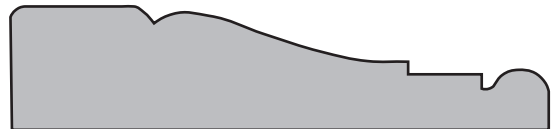

C M 371  
1<sup>1</sup>/<sub>16</sub> X 3 in.

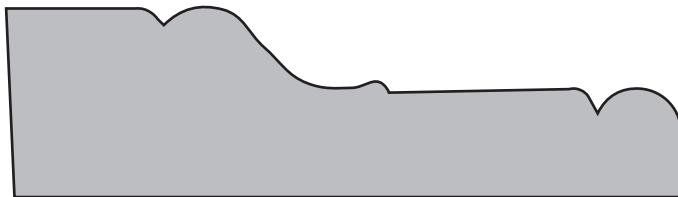

MD2  
1 X 3<sup>1</sup>/<sub>2</sub> in.

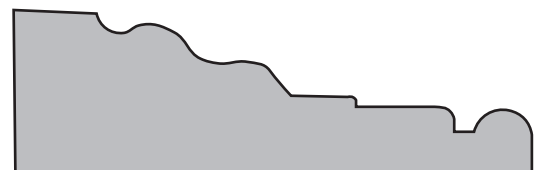

NH234  
7/8 X 2<sup>3</sup>/<sub>4</sub> in.

# CASING

MOULDINGS.CC  
FLEXIBLE MOULDING

Many more profiles available, call 888-883-3113 \* Fax 305-675-3738

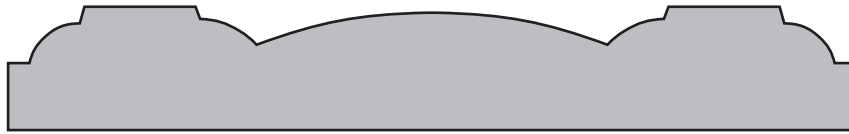

S M7  
1<sup>1</sup>/<sub>16</sub> X 4<sup>1</sup>/<sub>2</sub> in.

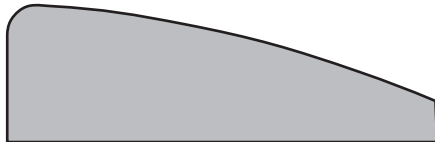

C M327  
1<sup>1</sup>/<sub>16</sub> X 2<sup>1</sup>/<sub>4</sub> in.

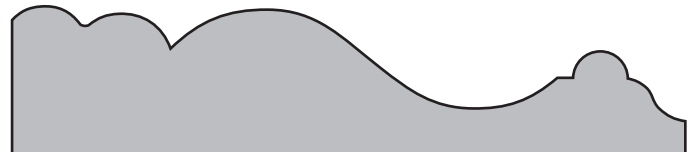

C KR350  
3/4 X 3<sup>1</sup>/<sub>2</sub> in.

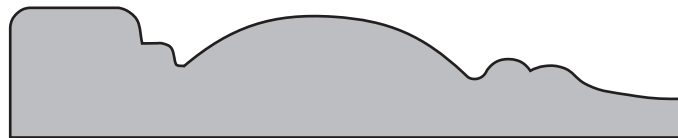

P M719  
1<sup>1</sup>/<sub>16</sub> X 3<sup>1</sup>/<sub>2</sub> in.

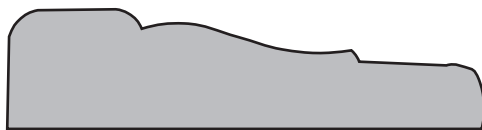

W M351  
1<sup>1</sup>/<sub>16</sub> X 2<sup>1</sup>/<sub>2</sub> in.



C BG275  
3/4 X 2<sup>3</sup>/<sub>4</sub> in.



R IDOUT376  
1 in. X 3 in.

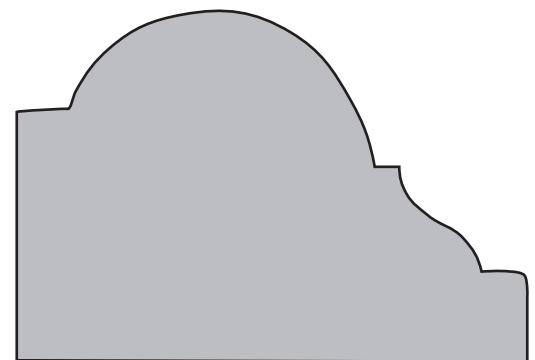

C AS 50  
1<sup>3</sup>/<sub>4</sub> X 2<sup>1</sup>/<sub>2</sub> in.



C KN425  
3/4 X 4<sup>1</sup>/<sub>4</sub> in.



# CASING

MOULDINGS.CC  
FLEXIBLE MOULDING

Many more profiles available, call 888-883-3113 \* Fax 305-675-3738

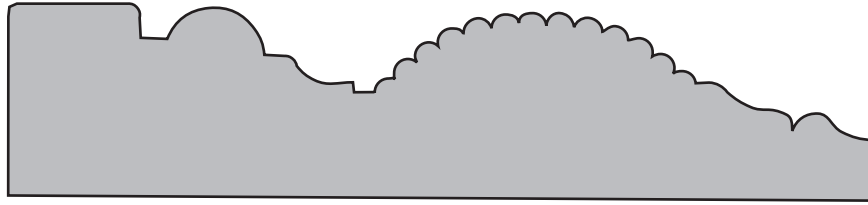

LS M2060  
1<sup>1</sup>/<sub>16</sub> X 4<sup>1</sup>/<sub>2</sub> in.

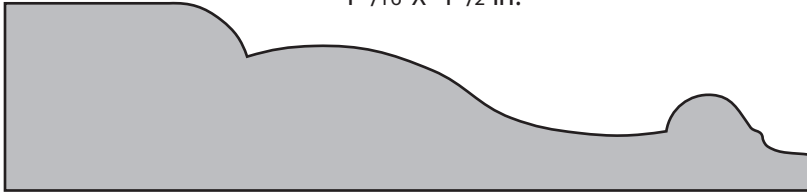

B M1188  
1 X 4<sup>1</sup>/<sub>4</sub> in.

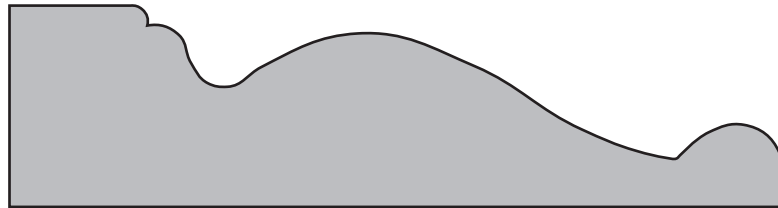

C N400  
1 X 4 in.

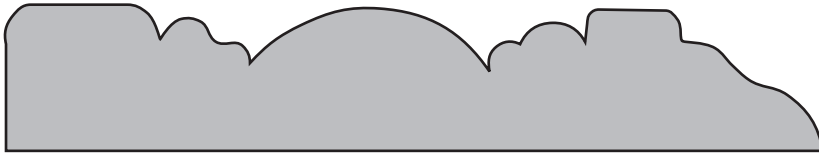

C BG 400  
3/4 X 4<sup>1</sup>/<sub>4</sub> in.

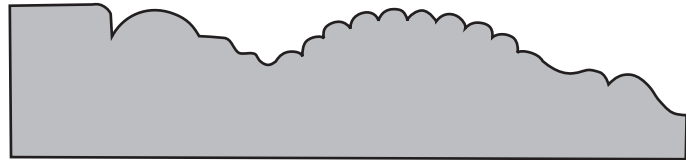

C RC 350  
3/4 X 3<sup>1</sup>/<sub>2</sub> in.



C RC 425  
3/4 X 4<sup>1</sup>/<sub>2</sub> in.

Many more profiles available, call 888-883-3113 \* Fax 305-675-3738



C G A425  
1 X 4<sup>1</sup>/<sub>4</sub> in.

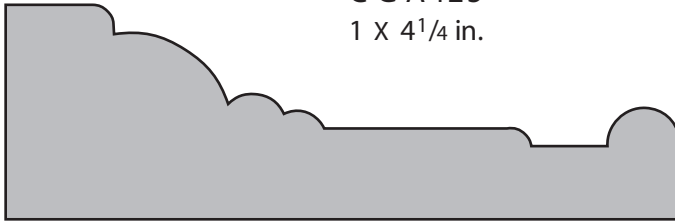

C O X C O M B  
1<sup>1</sup>/<sub>16</sub> X 3<sup>1</sup>/<sub>2</sub> in.

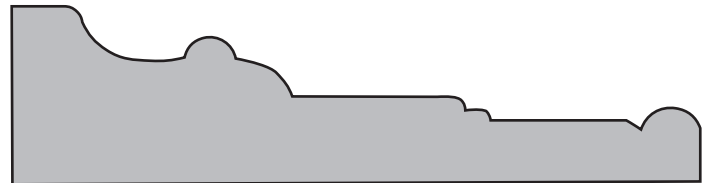

N H 3 5 8  
7/8 X 3<sup>5</sup>/<sub>8</sub> in.

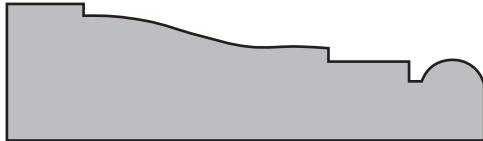

W M 3 7 1  
1<sup>1</sup>/<sub>16</sub> X 2<sup>1</sup>/<sub>2</sub> in.

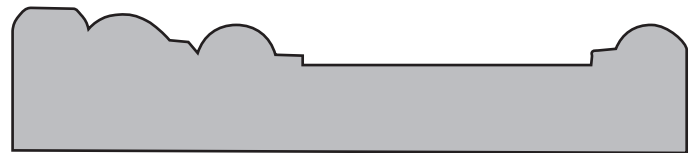

C K N 3 5 0  
3/4 X 3<sup>1</sup>/<sub>2</sub> in.

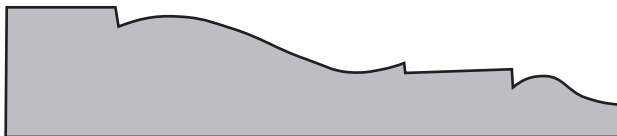

C M 3 6 1  
1<sup>1</sup>/<sub>16</sub> X 3<sup>1</sup>/<sub>4</sub> in.



S M 8 3  
3/4 X 4<sup>1</sup>/<sub>8</sub> in.

Many more profiles available, call 888-883-3113 \* Fax 305-675-3738

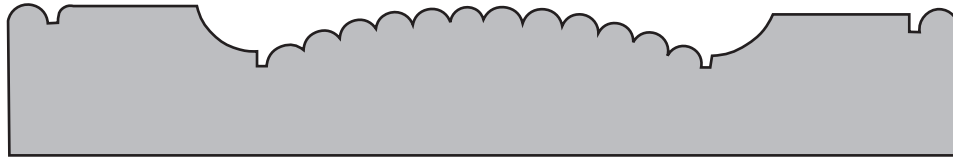

S M80  
3/4 X 5 in.

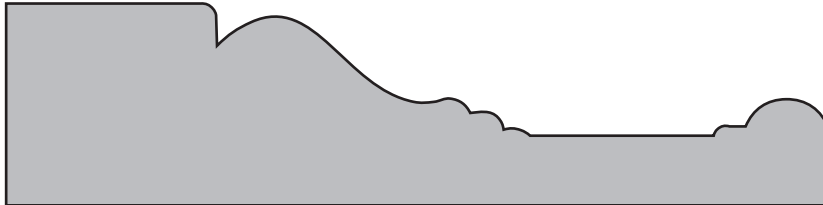

C J F 425  
1 X 4 1/4 in.



LWM 97  
3/4 X 3 1/2 in.

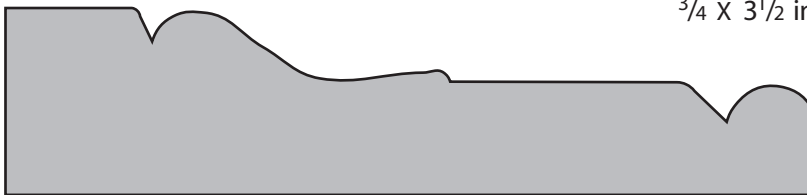

C 425  
1 X 4 1/4 in.

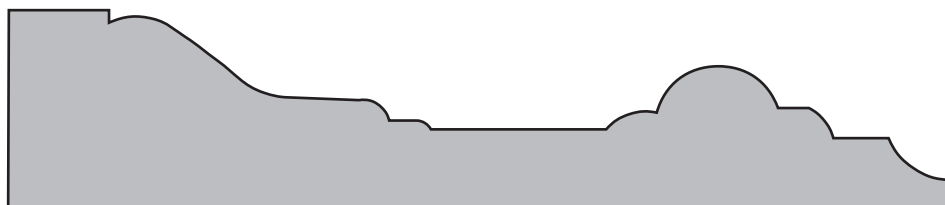

MIS S J ENNY  
1 1/16 X 4 7/8 in.



C AG 425  
1 1/16 X 4 1/4 in.

# CASING

MOULDINGS.CC  
FLEXIBLE MOULDING

Many more profiles available, call 888-883-3113 \* Fax 305-675-3738



C M433  
9/16 X 3 1/4 in.



C M473  
9/16 X 2 1/4 in.

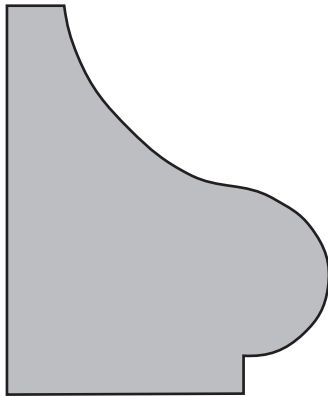

C AS 30  
1 3/4 X 2 in.



C M452  
1 1/16 X 2 1/2 in.



S M2050  
1 1/16 X 4 1/2 in.

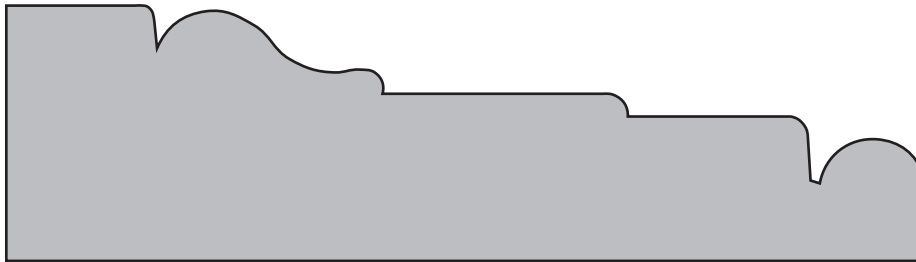

B M995  
1 5/16 X 4 3/4 in.

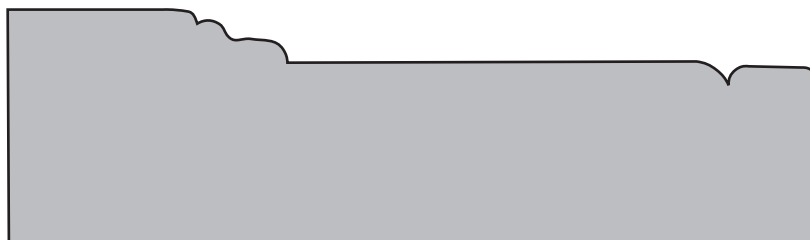

S M 5701  
1 1/4 X 4 1/2 in.

# CASING

MOULDINGS.CC  
FLEXIBLE MOULDING

Many more profiles available, call 888-883-3113 \* Fax 305-675-3738

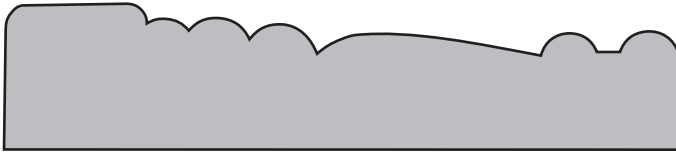

C AM350  
 $\frac{3}{4}$  X  $3\frac{1}{2}$  in.

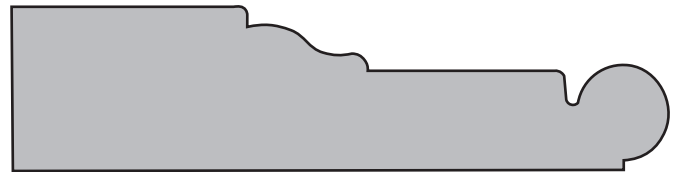

B M1455  
 $\frac{7}{8}$  X  $4\frac{3}{32}$  in.

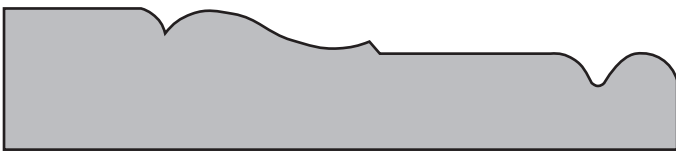

C 352  
 $\frac{3}{4}$  X  $3\frac{1}{2}$  in.

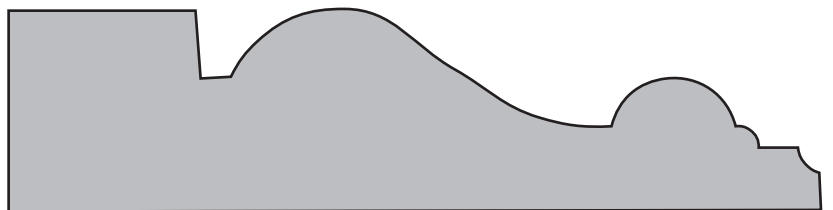

R B I S P R 3  
 $1\frac{1}{16}$  X  $4\frac{1}{4}$  in.



B M255  
 $1\frac{3}{16}$  X  $3\frac{15}{16}$  in.

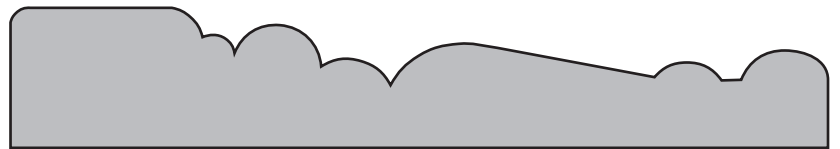

C AM400  
 $\frac{3}{4}$  X  $4\frac{1}{4}$  in.

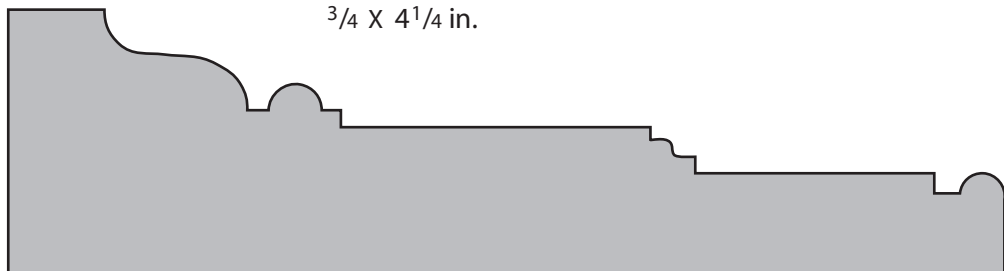

S M84  
 $1\frac{3}{8}$  X  $5\frac{1}{4}$  in.

# CASING

MOULDINGS.CC  
FLEXIBLE MOULDING

Many more profiles available, call 888-883-3113 \* Fax 305-675-3738

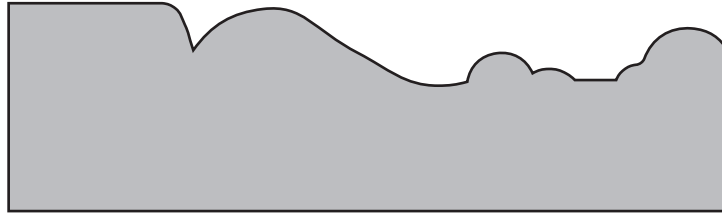

R B1208  
1<sup>1</sup>/<sub>16</sub> X 3<sup>3</sup>/<sub>4</sub> in.

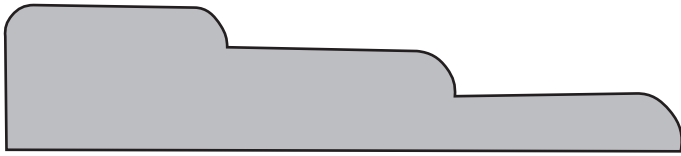

C TE 350  
3/4 X 3<sup>1</sup>/<sub>2</sub> in.



C M683  
1<sup>1</sup>/<sub>16</sub> X 3<sup>1</sup>/<sub>4</sub> in.



TM1  
1<sup>1</sup>/<sub>16</sub> X 3<sup>1</sup>/<sub>4</sub> in.

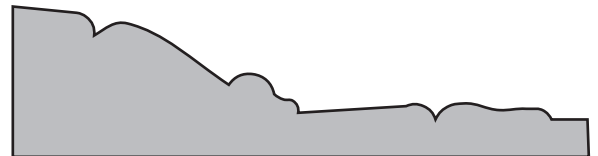

399  
3/4 X 3 in.

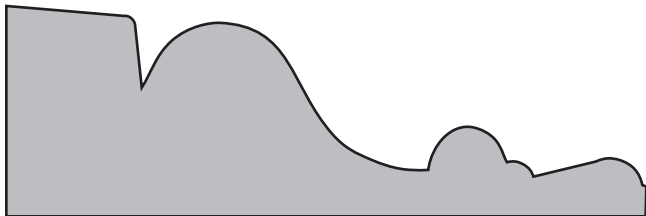

MS1661 S PR OT LONG  
1<sup>1</sup>/<sub>8</sub> X 3<sup>3</sup>/<sub>8</sub> in.

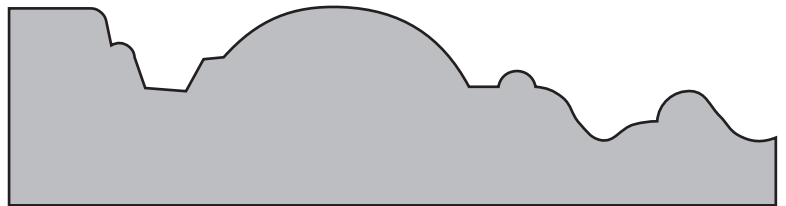

S M2051  
1 X 4 in.

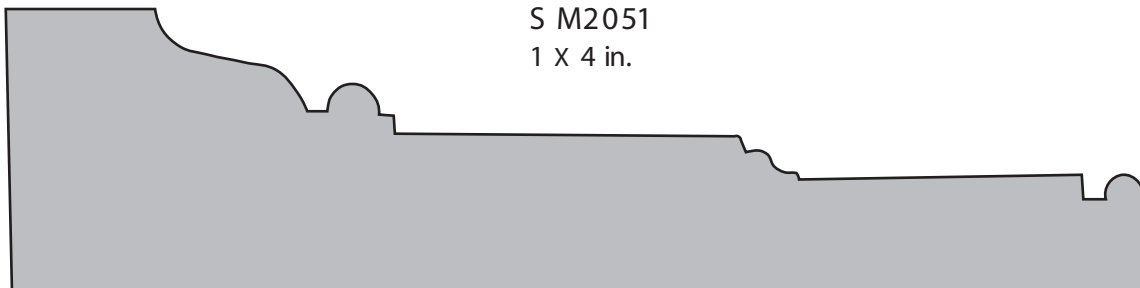

CW1 Also available: 1<sup>7</sup>/<sub>16</sub> X 4 in.  
1<sup>7</sup>/<sub>16</sub> X 5<sup>5</sup>/<sub>8</sub> in.



Many more profiles available, call 888-883-3113 \* Fax 305-675-3738

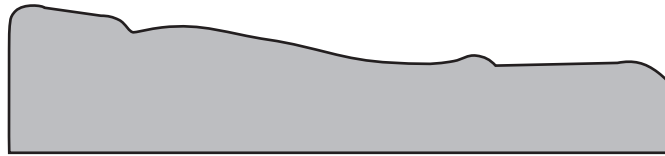

C 351  
3/4 X 3 1/2 in.



W M444  
1 1/16 X 3 1/4 in.

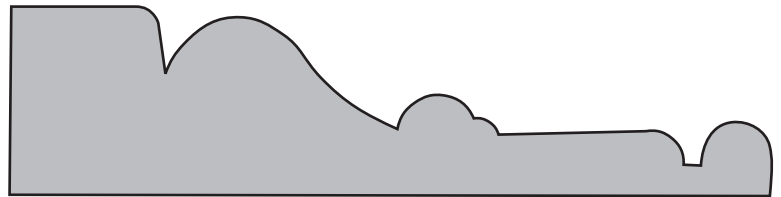

LDF CA4  
1 X 4 in.



C KN234  
3/4 X 2 3/4 in.

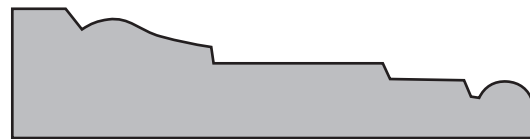

S M82  
1 1/16 X 2 3/4 in.

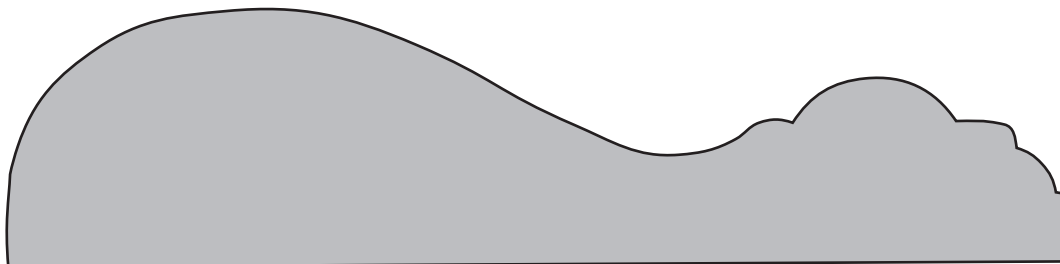

E C490  
1 5/16 X 5 1/2 in.

Many more profiles available, call 888-883-3113 \* Fax 305-675-3738

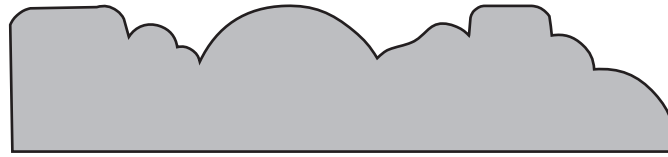

C BG 300  
 $\frac{3}{4}$  X  $3\frac{1}{2}$  in.

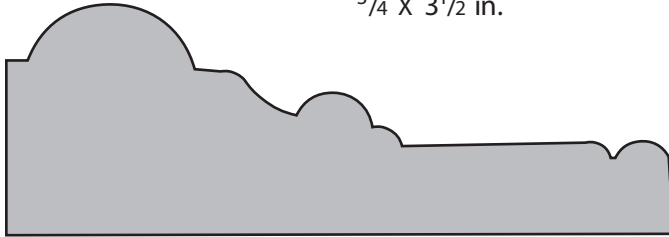

S M 47  
 $1\frac{1}{4}$  X  $3\frac{1}{2}$  in

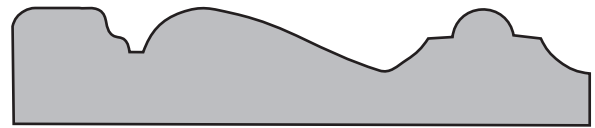

P T 312  
 $\frac{5}{8}$  X 3 in.

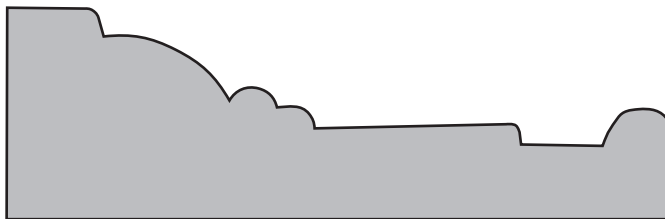

S M 2  
 $1\frac{1}{16}$  X  $3\frac{5}{8}$  in.

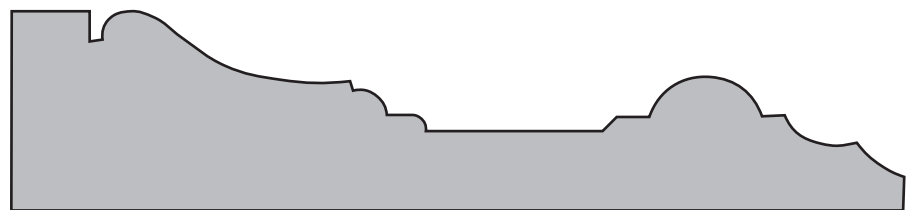

C M 466  
 $1\frac{1}{16}$  X  $4\frac{5}{8}$  in.

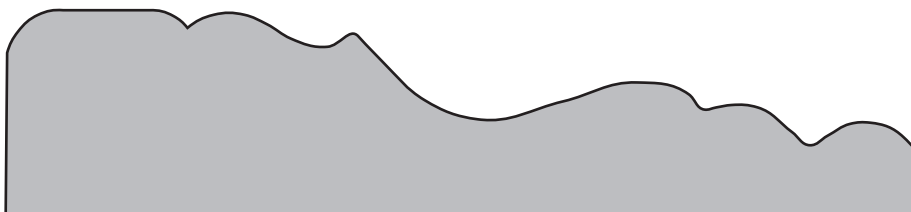

P RE SIDE NTIAL  
 $1\frac{1}{16}$  X  $4\frac{3}{4}$  in.

Many more profiles available, call 888-883-3113 \* Fax 305-675-3738

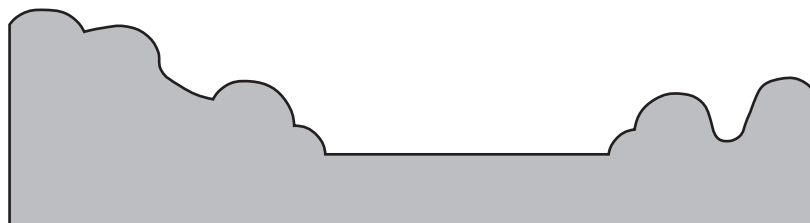

P LAR GE HOWE  
1<sup>1</sup>/<sub>8</sub> X 4<sup>1</sup>/<sub>4</sub> in.



TMMH (Mini Howe)  
1<sup>1</sup>/<sub>16</sub> X 2<sup>3</sup>/<sub>4</sub> in.

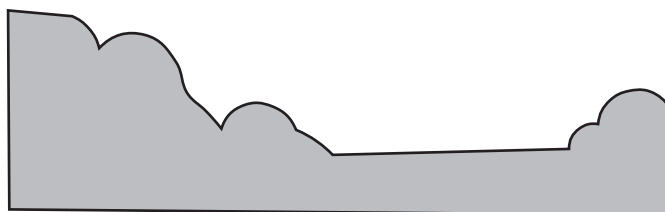

DELTA HOWE  
1 X 3<sup>7</sup>/<sub>16</sub> in.

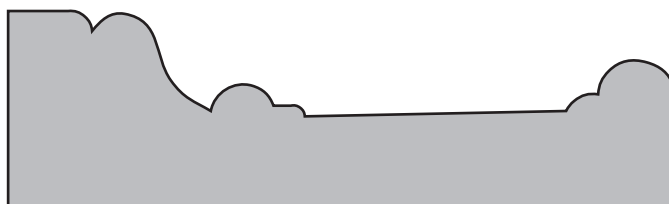

C KN535  
1 X 3<sup>1</sup>/<sub>2</sub> in.

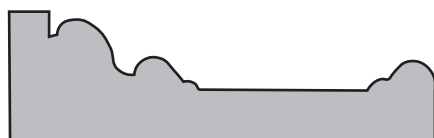

C M10  
1<sup>1</sup>/<sub>16</sub> X 2<sup>3</sup>/<sub>8</sub> in.

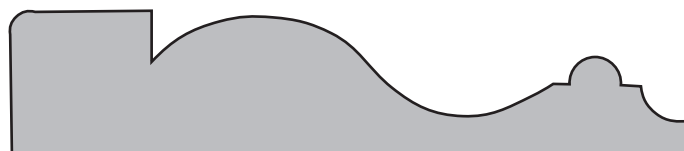

C VA350  
3/4 X 3<sup>1</sup>/<sub>2</sub> in.

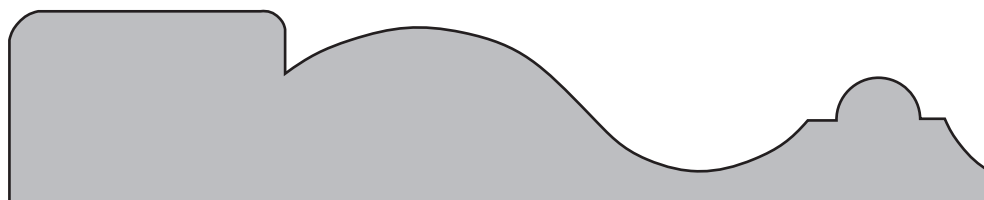

C VA525  
1 X 5<sup>1</sup>/<sub>4</sub> in.



MS 11  
1<sup>1</sup>/<sub>16</sub> X 3<sup>1</sup>/<sub>4</sub> in.

# BACK BANDS

MOULDINGS.CC  
FLEXIBLE MOULDING

Many more profiles available, call 888-883-3113 \* Fax 305-675-3738

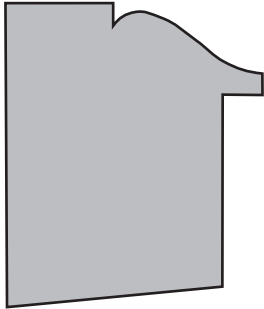

C282  
1<sup>5</sup>/<sub>16</sub> X 1<sup>5</sup>/<sub>8</sub> in.

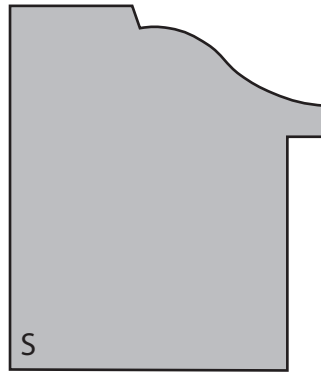

C M809  
1<sup>3</sup>/<sub>8</sub> X 1<sup>5</sup>/<sub>8</sub> in.

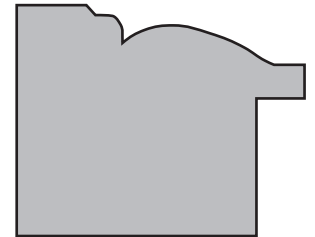

4046US BB  
1<sup>3</sup>/<sub>16</sub> X 1<sup>1</sup>/<sub>2</sub> in.

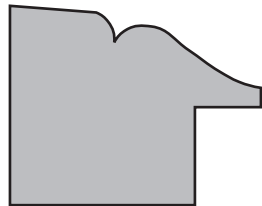

97BB  
1<sup>1</sup>/<sub>8</sub> X 1<sup>1</sup>/<sub>16</sub> in.

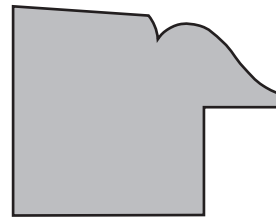

S M68  
1<sup>1</sup>/<sub>16</sub> X 1<sup>7</sup>/<sub>16</sub> in.

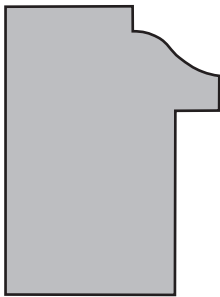

B R 285  
1<sup>1</sup>/<sub>8</sub> X 1<sup>1</sup>/<sub>2</sub> in.

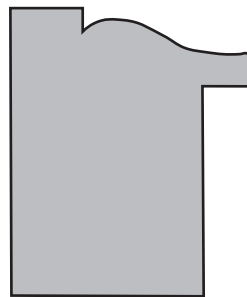

4048US -B B  
1<sup>1</sup>/<sub>4</sub> X 1<sup>1</sup>/<sub>2</sub> in.

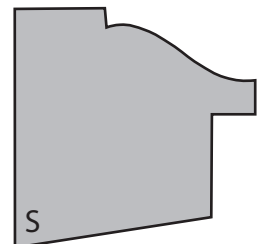

C 281  
1<sup>5</sup>/<sub>16</sub> X 1<sup>5</sup>/<sub>16</sub> in.

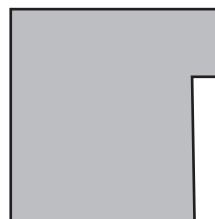

3436BB  
1<sup>1</sup>/<sub>16</sub> X 1<sup>1</sup>/<sub>8</sub> in.

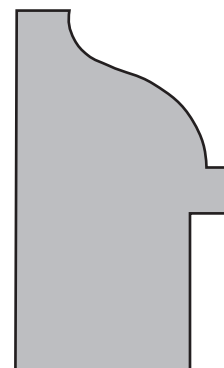

S M2513  
1<sup>1</sup>/<sub>8</sub> X 1<sup>7</sup>/<sub>8</sub> in.

# BACK BANDS

MOULDINGS.CC  
FLEXIBLE MOULDING

Many more profiles available, call 888-883-3113 \* Fax 305-675-3738

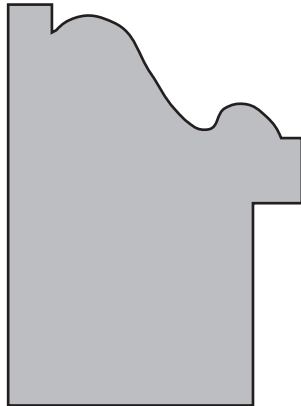

S M 2501-2  
1<sup>9</sup>/<sub>16</sub> X 2<sup>1</sup>/<sub>8</sub> in.



B B 200  
1<sup>1</sup>/<sub>2</sub> X 2<sup>3</sup>/<sub>8</sub> in.

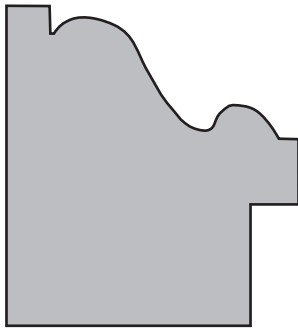

S M 2501  
1<sup>9</sup>/<sub>16</sub> X 1<sup>11</sup>/<sub>16</sub> in.

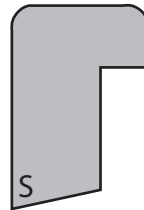

C M 280  
1<sup>1</sup>/<sub>16</sub> X 1<sup>1</sup>/<sub>16</sub> in.

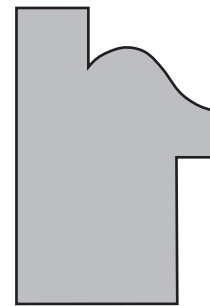

S M 2510  
1<sup>1</sup>/<sub>16</sub> X 1<sup>1</sup>/<sub>2</sub> in.

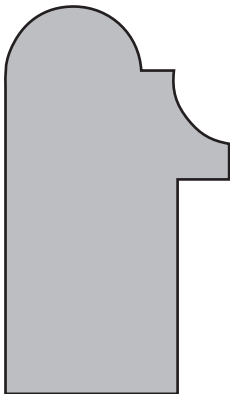

S M 2511-2  
1<sup>3</sup>/<sub>16</sub> X 2 in.

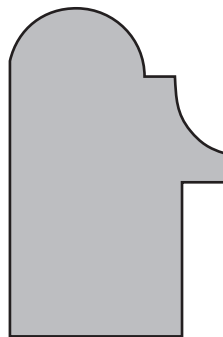

S M 2511  
1<sup>3</sup>/<sub>16</sub> X 1<sup>3</sup>/<sub>4</sub> in.

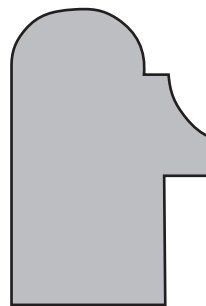

C M 289  
1<sup>1</sup>/<sub>16</sub> X 1<sup>9</sup>/<sub>16</sub> in.

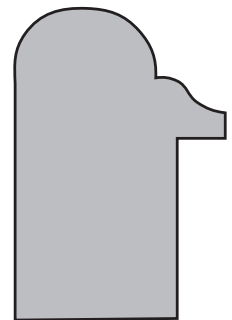

C RC 150  
1 X 1<sup>5</sup>/<sub>8</sub> in.  
Also Available:  
5/8 R abbe tt  
1<sup>1</sup>/<sub>16</sub> R abbe tt

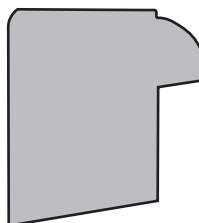

G P 281  
1 X 1<sup>1</sup>/<sub>8</sub> in.



C M 281  
1<sup>1</sup>/<sub>16</sub> X 1<sup>1</sup>/<sub>8</sub> in.

# CROWN

MOULDINGS.CC  
FLEXIBLE MOULDING

Many more profiles available, call 888-883-3113 \* Fax 305-675-3738

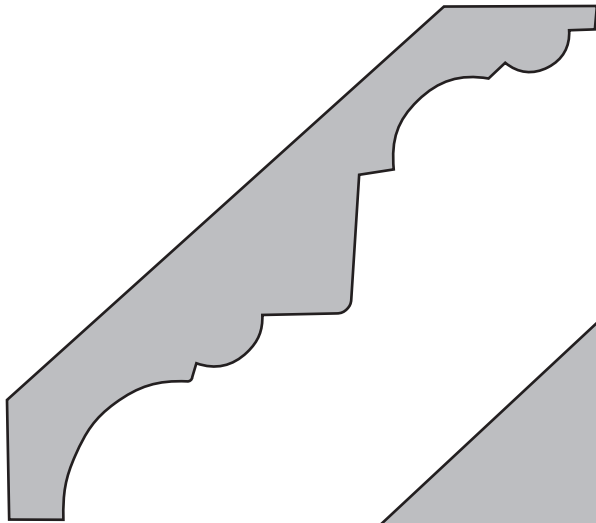

S M27  
7/8 X 4 1/8 in.

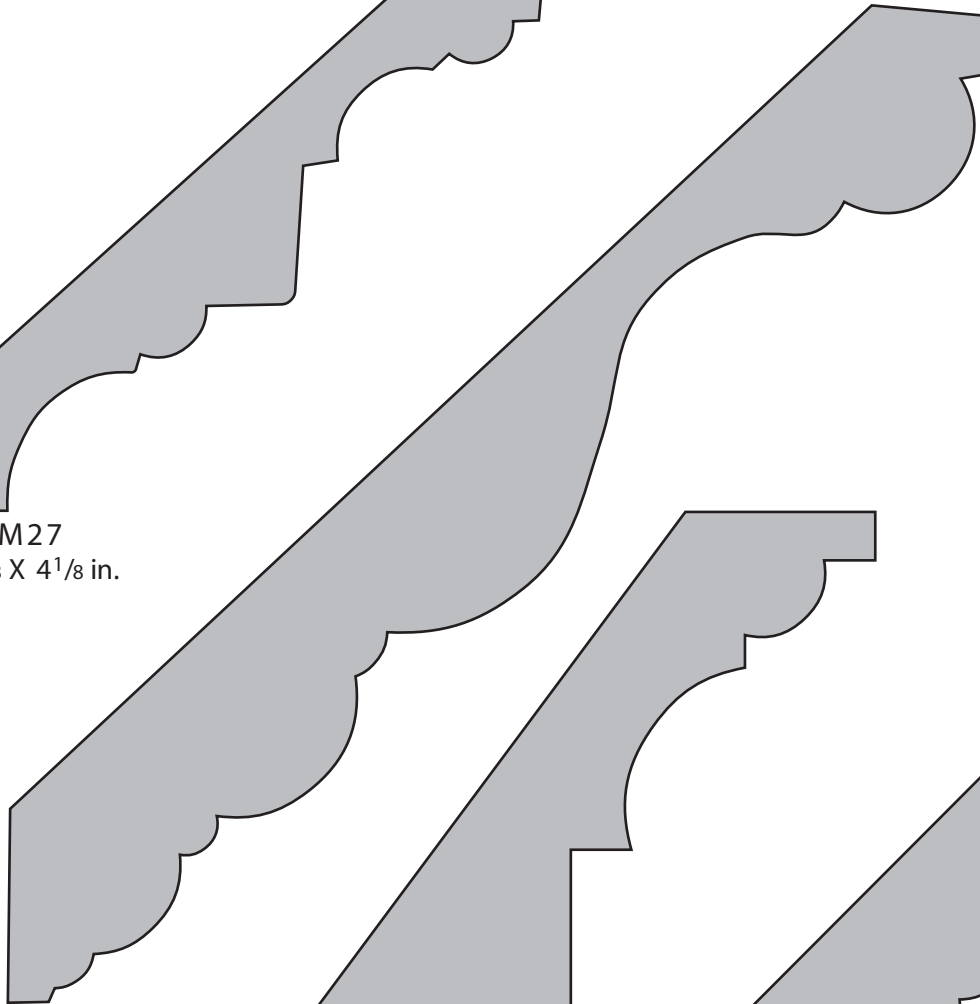

S M603  
1 X 7/4 in.

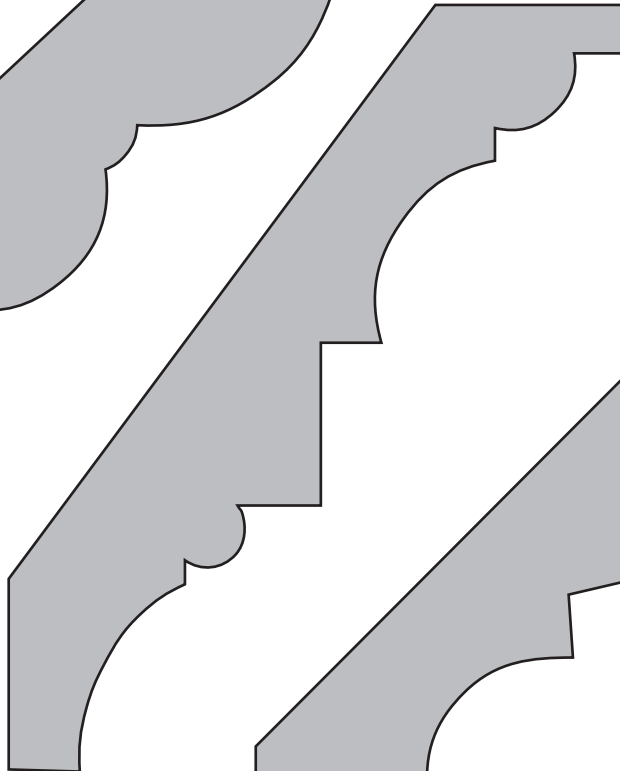

S M29  
1 11/16 X 5 1/8 in.

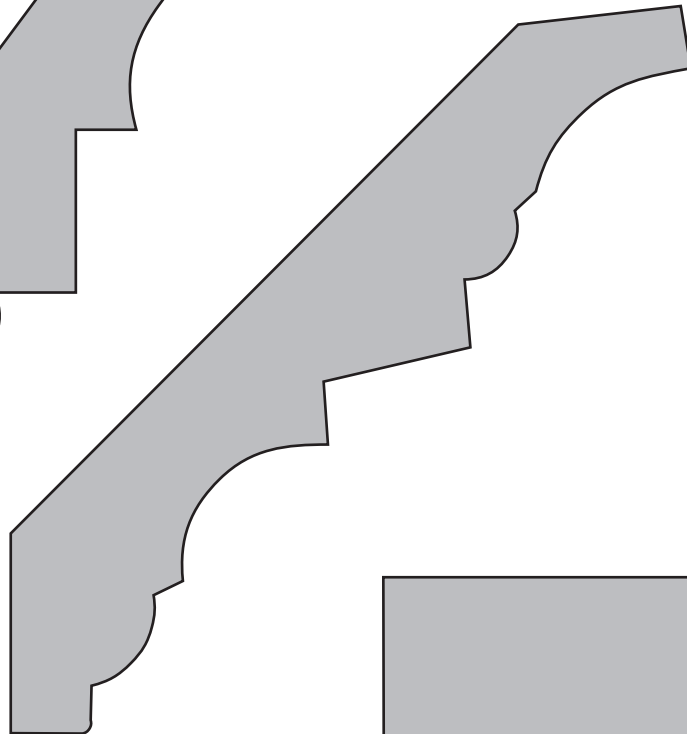

BM6  
1 X 5/4 in.



S M42  
2 1/4 X 1 5/8 in.



# CROWN

MOULDINGS.CC  
FLEXIBLE MOULDING

Many more profiles available, call 888-883-3113 \* Fax 305-675-3738

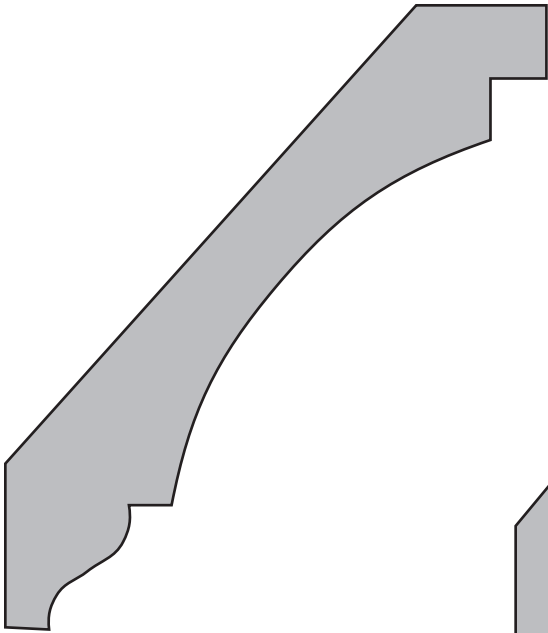

AH40  
1<sup>1</sup>/<sub>16</sub> X 4<sup>1</sup>/<sub>4</sub> in.

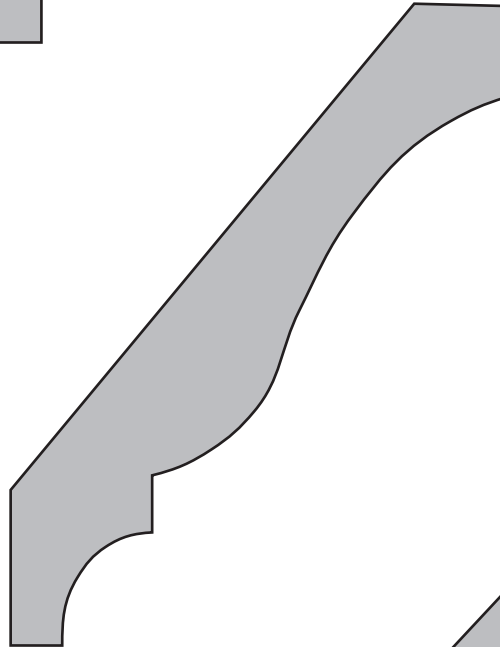

C M48  
9<sup>9</sup>/<sub>16</sub> X 4<sup>1</sup>/<sub>4</sub> in.

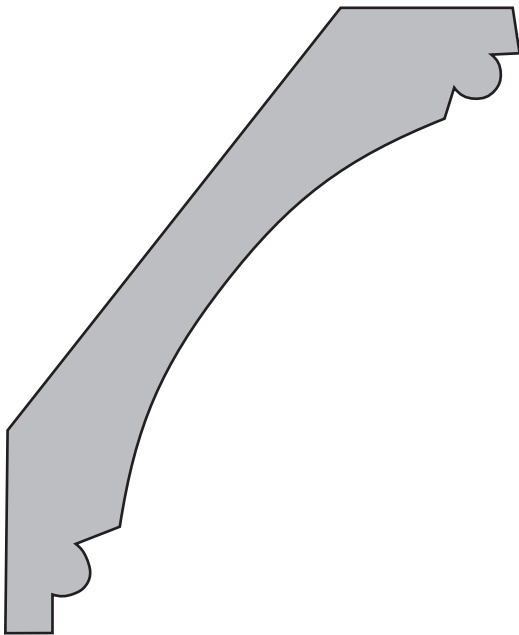

WM80  
1<sup>1</sup>/<sub>16</sub> X 4<sup>1</sup>/<sub>4</sub> in.

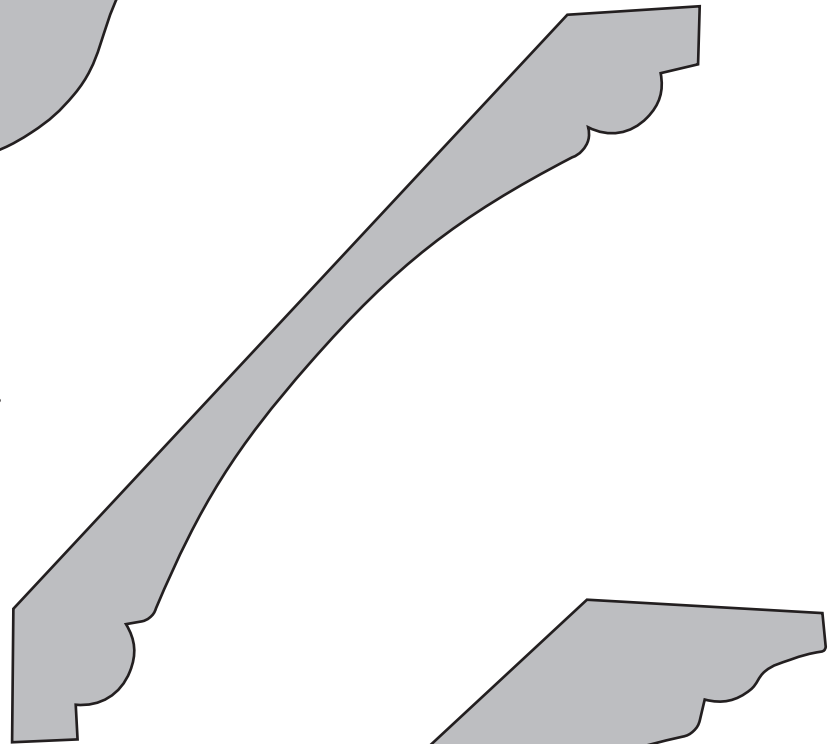

C M541  
1<sup>1</sup>/<sub>16</sub> X 5<sup>1</sup>/<sub>4</sub> in.

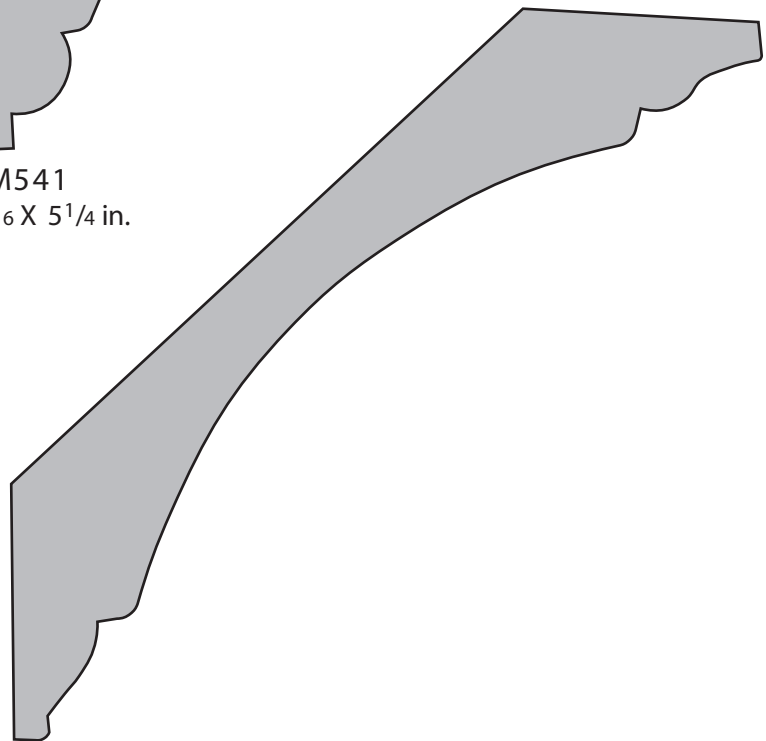

COLONIAL COVE  
3<sup>3</sup>/<sub>4</sub> X 5<sup>1</sup>/<sub>4</sub> in.

# CROWN

MOULDINGS.CC  
FLEXIBLE MOULDING

Many more profiles available, call 888-883-3113 \* Fax 305-675-3738

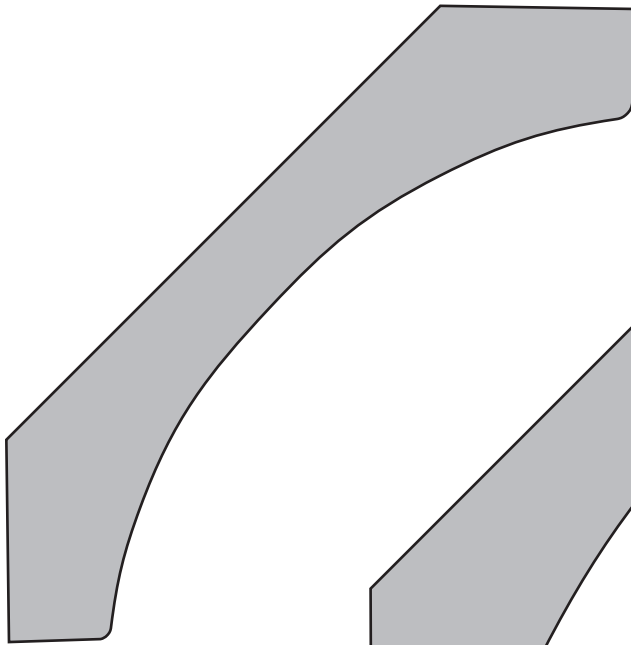

S M81  
1 1/16 X 4 5/8 in.  
Also Available:  
S M86  
1 1/2 X 6 in

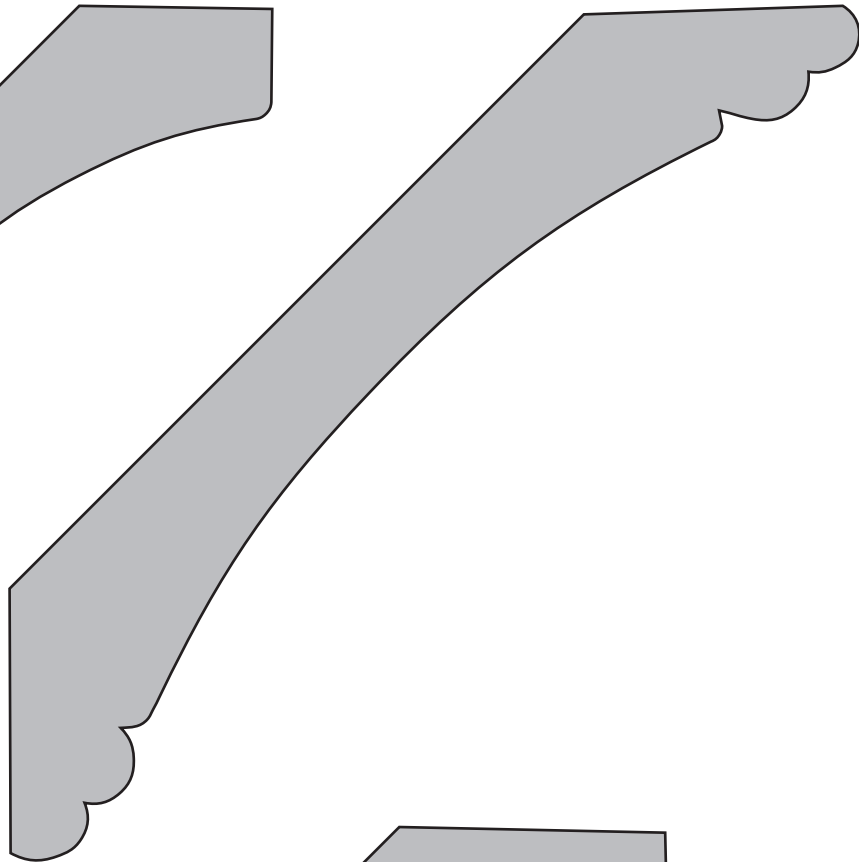

R BCC M625  
1 X 6 1/4 in.

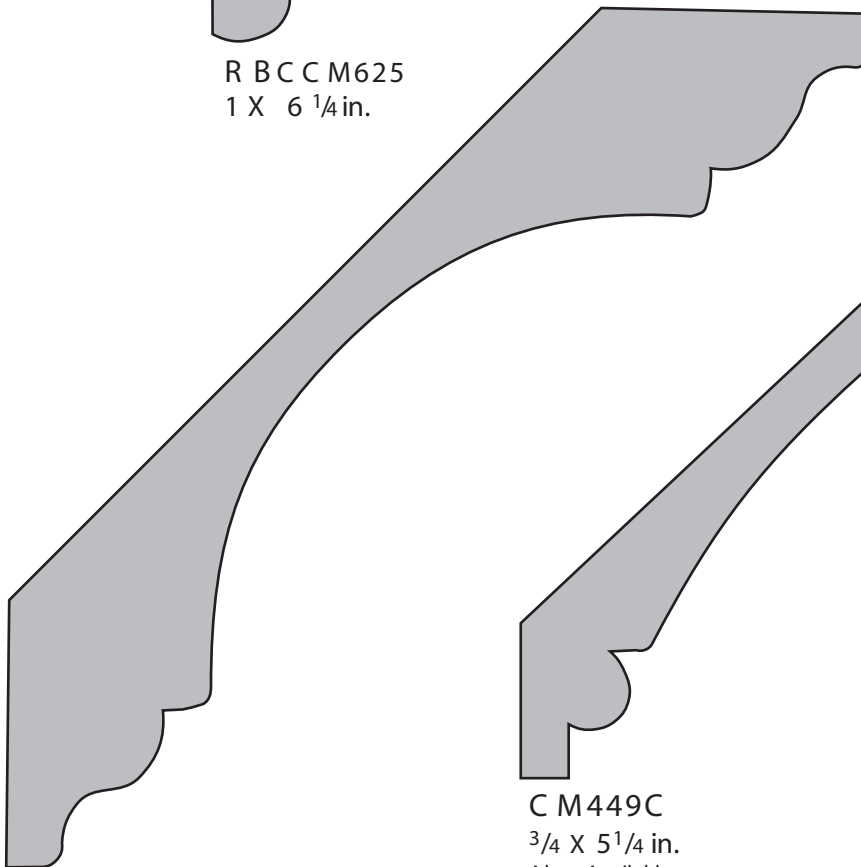

TP41/TLC500  
1 1/8 X 6 1/4 in.

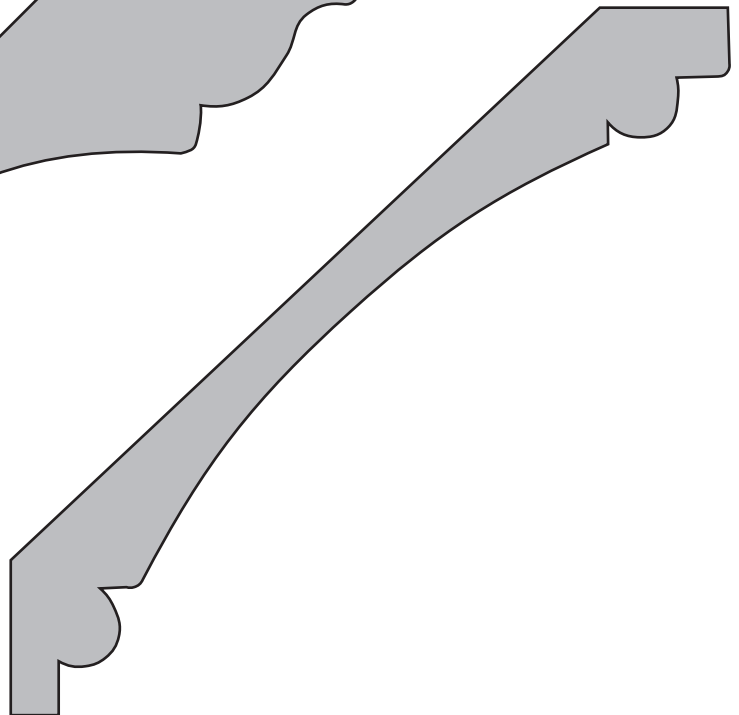

C M449C  
3/4 X 5 1/4 in.  
Also Available:  
C M6449C  
3/4 X 6 1/4 in.

# CROWN

MOULDINGS.CC  
FLEXIBLE MOULDING

Many more profiles available, call 888-883-3113 \* Fax 305-675-3738

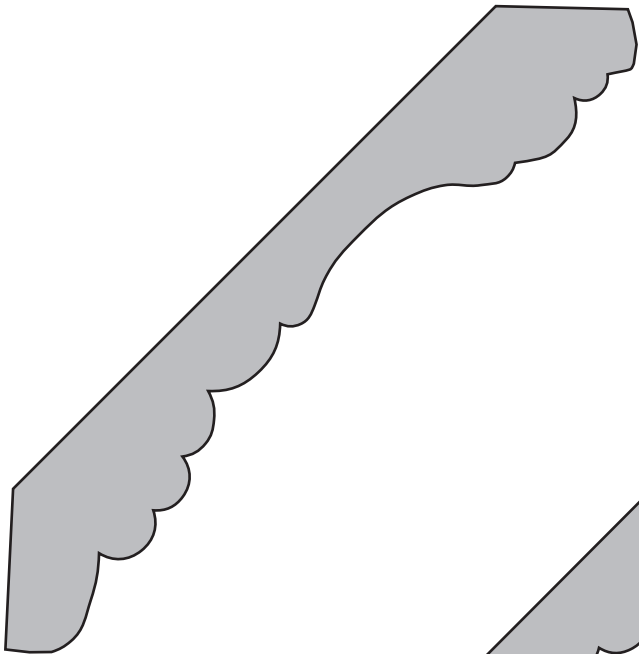

S M 1136  
3/4 X 4 7/8 in.

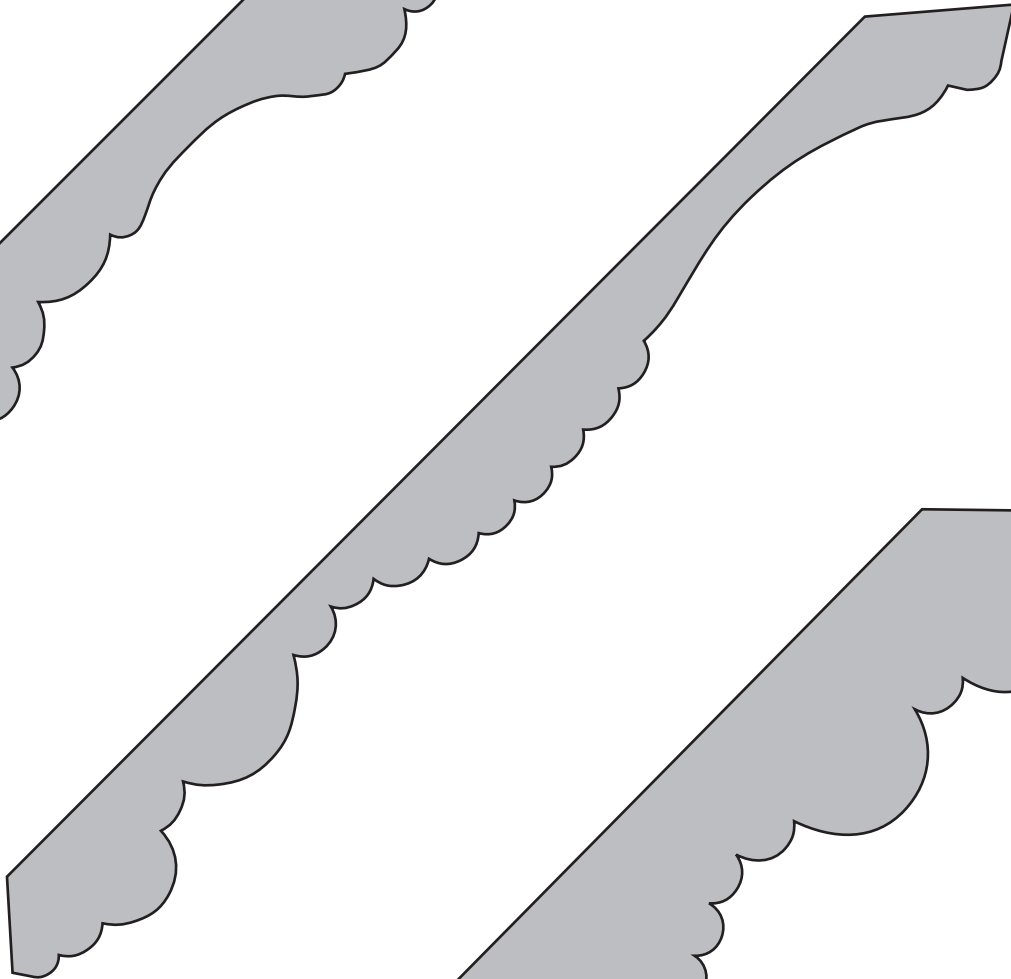

B B S 725  
1 1/16 X 7 1/4 in.

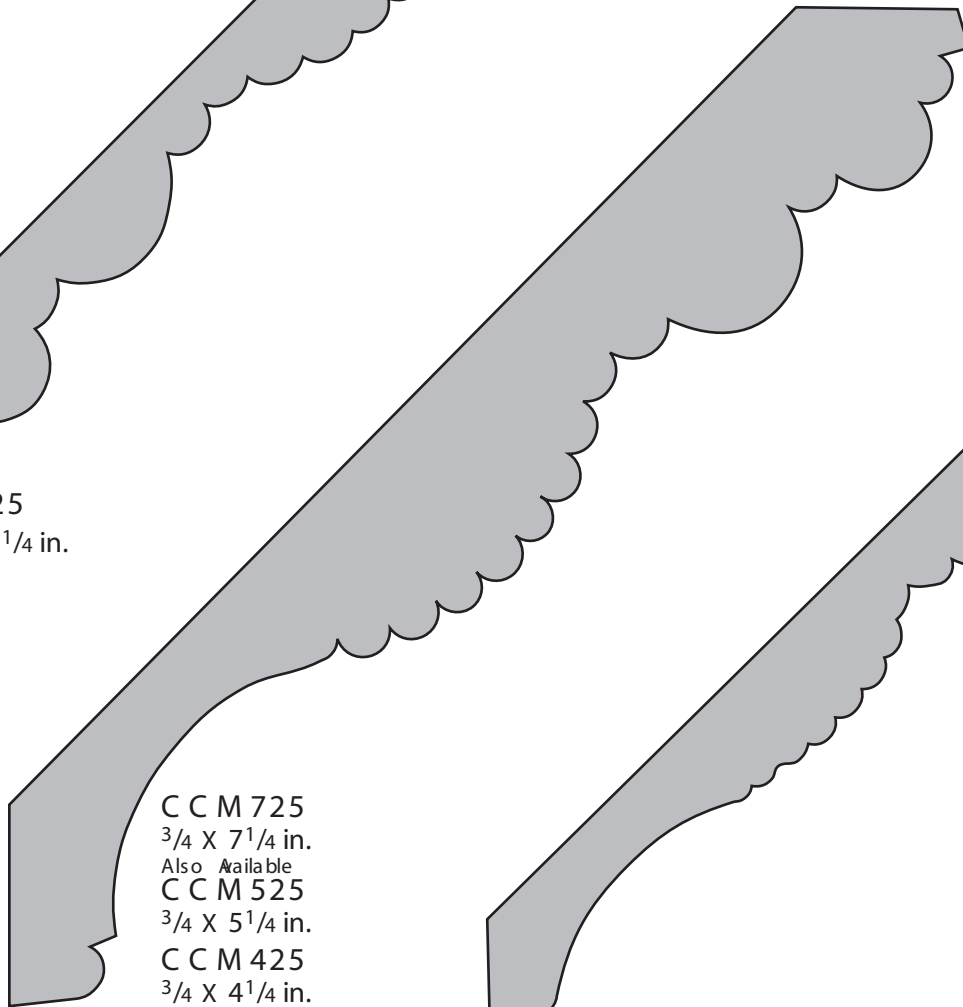

C C M 725  
3/4 X 7 1/4 in.  
Also Available  
C C M 525  
3/4 X 5 1/4 in.  
C C M 425  
3/4 X 4 1/4 in.

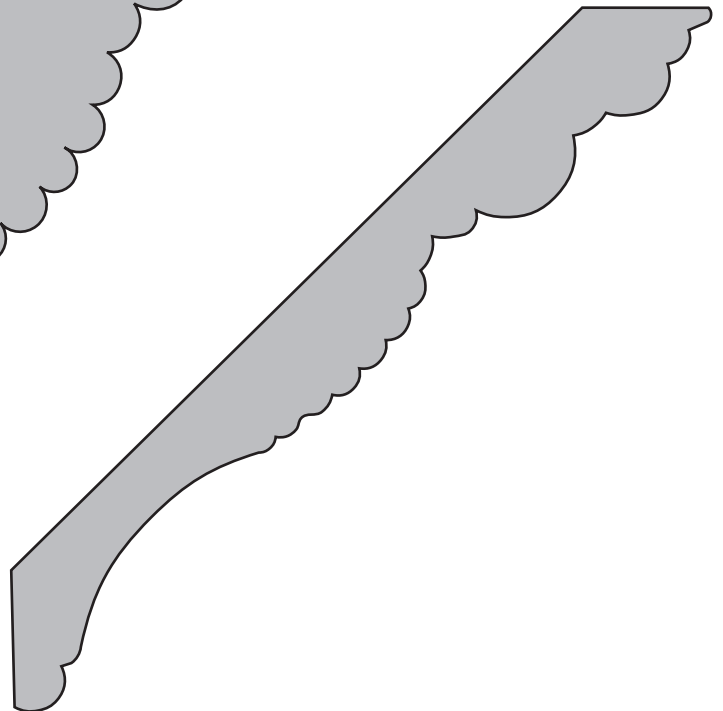

B B S 111  
3/4 X 5 1/4 in.

# CROWN

MOULDINGS.CC  
FLEXIBLE MOULDING

Many more profiles available, call 888-883-3113 \* Fax 305-675-3738

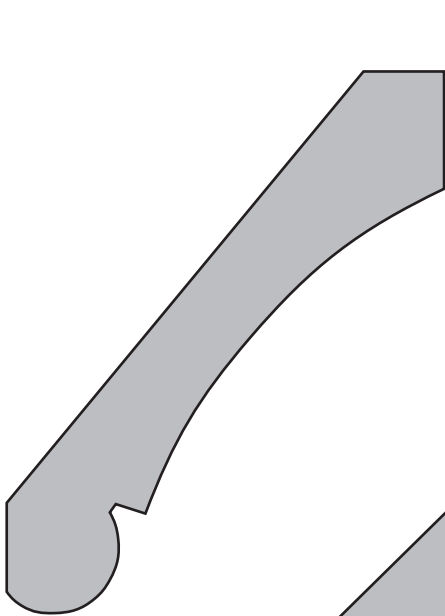

S M21  
1<sup>1</sup>/<sub>16</sub> X 3<sup>1</sup>/<sub>2</sub> in.



E C36  
1<sup>1</sup>/<sub>16</sub> X 7<sup>1</sup>/<sub>4</sub> in.

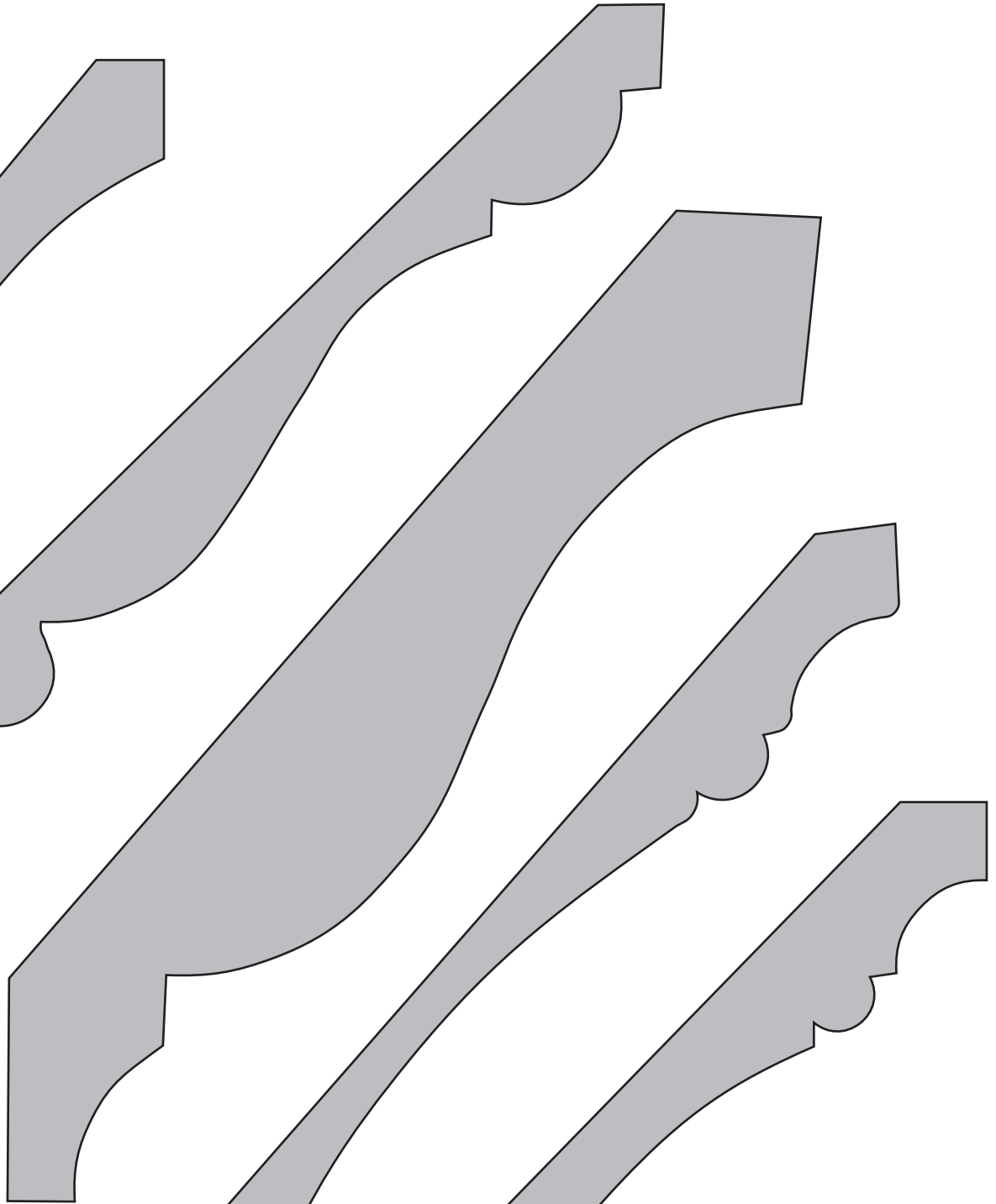

S M38  
1<sup>3</sup>/<sub>8</sub> X 8

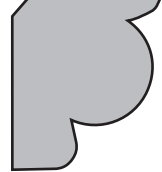

C M725L  
3/4 X 7<sup>1</sup>/<sub>4</sub> in.

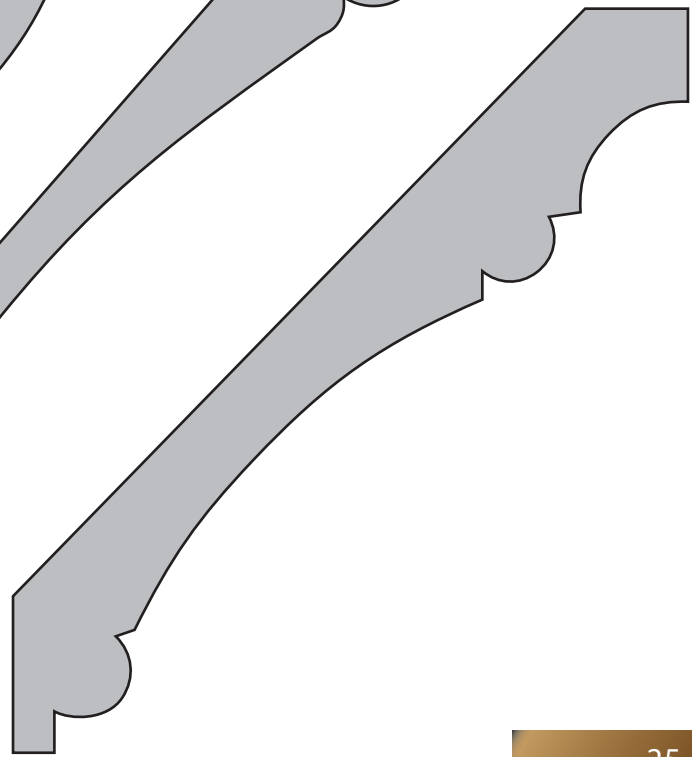

C M525L  
3/4 X 5<sup>1</sup>/<sub>4</sub> in.

# CROWN

MOULDINGS.CC  
FLEXIBLE MOULDING

Many more profiles available, call 888-883-3113 \* Fax 305-675-3738

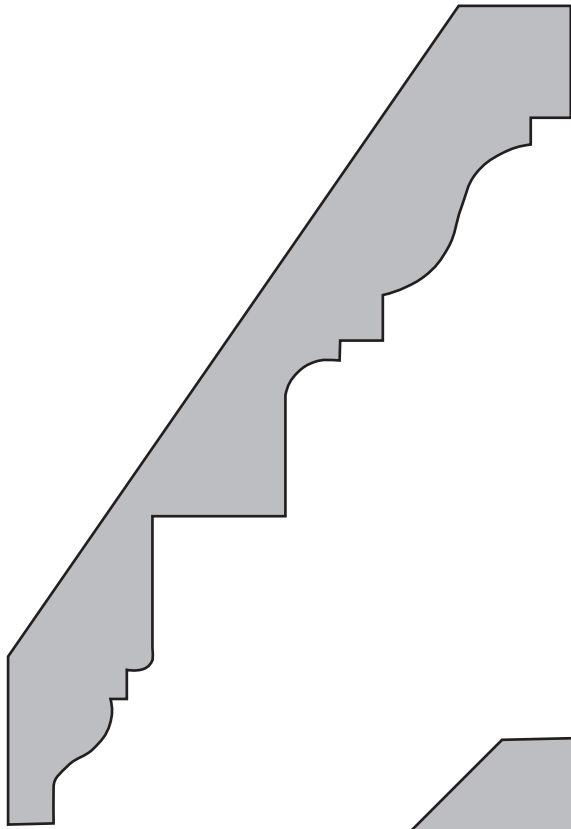

S MB2  
3/4 X 5 1/4 in.

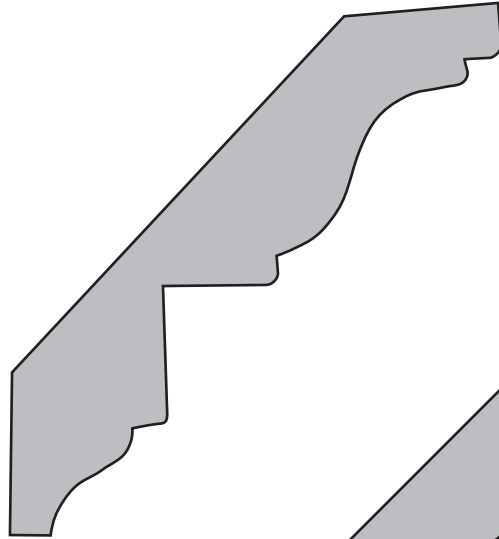

C MB75L  
3/4 X 3 1/4 in.

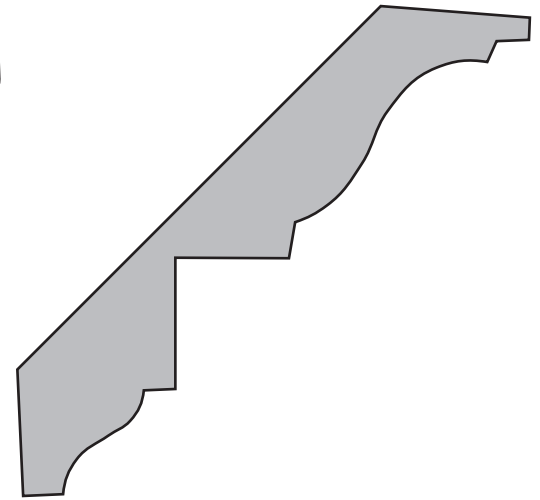

R B4  
5/8 X 3 1/2 in.

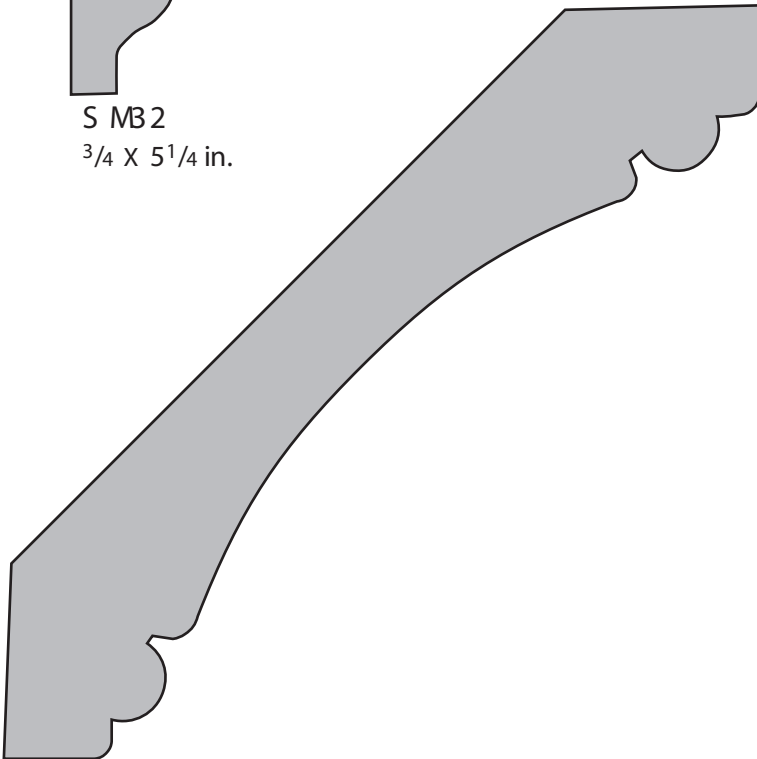

B M51245  
1 5/16 X 5 1/2 in.

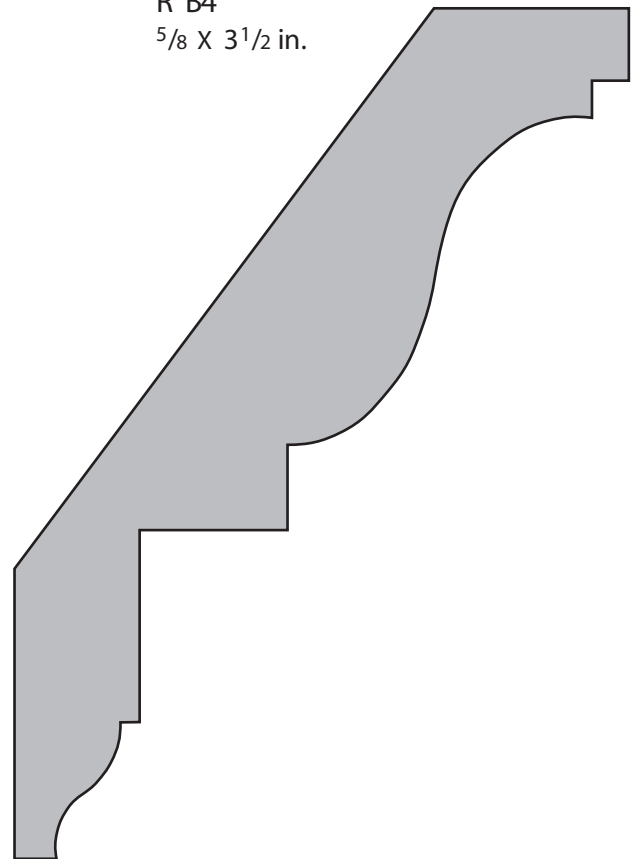

R B7  
1 1/16 X 5 1/4 in.

# CROWN

MOULDINGS.CC  
FLEXIBLE MOULDING

Many more profiles available, call 888-883-3113 \* Fax 305-675-3738

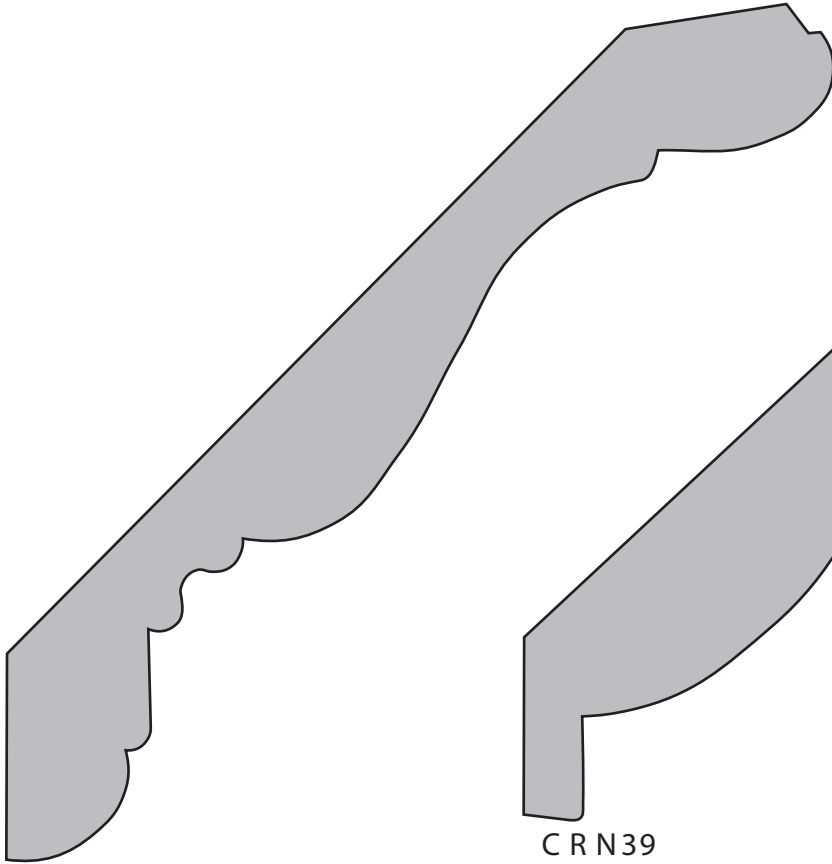

AH61  
1 X 6 in.

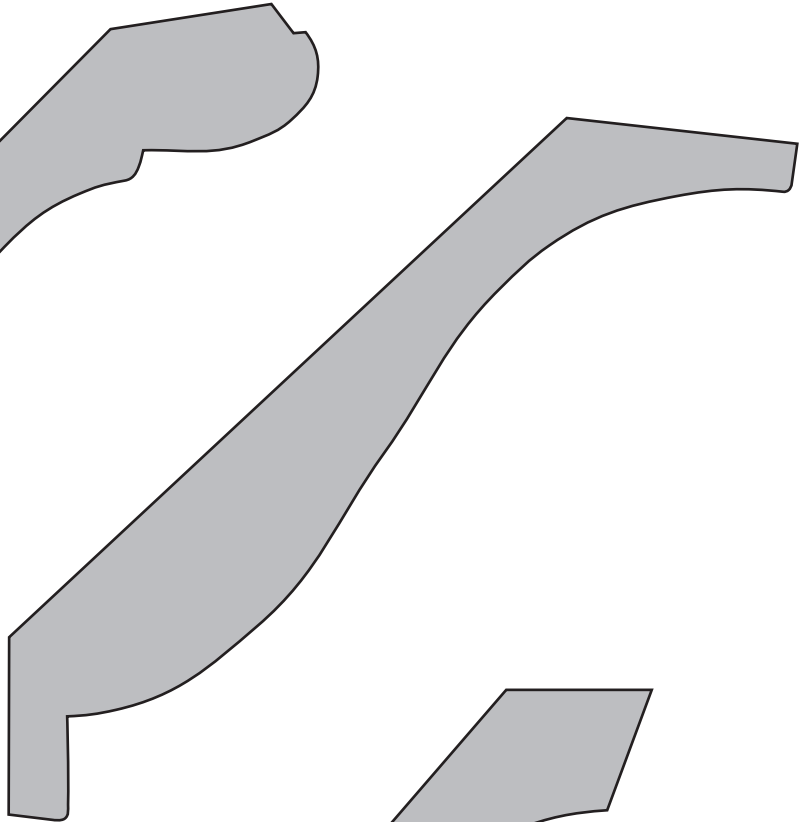

CRN39  
1 X 5 1/4 in.

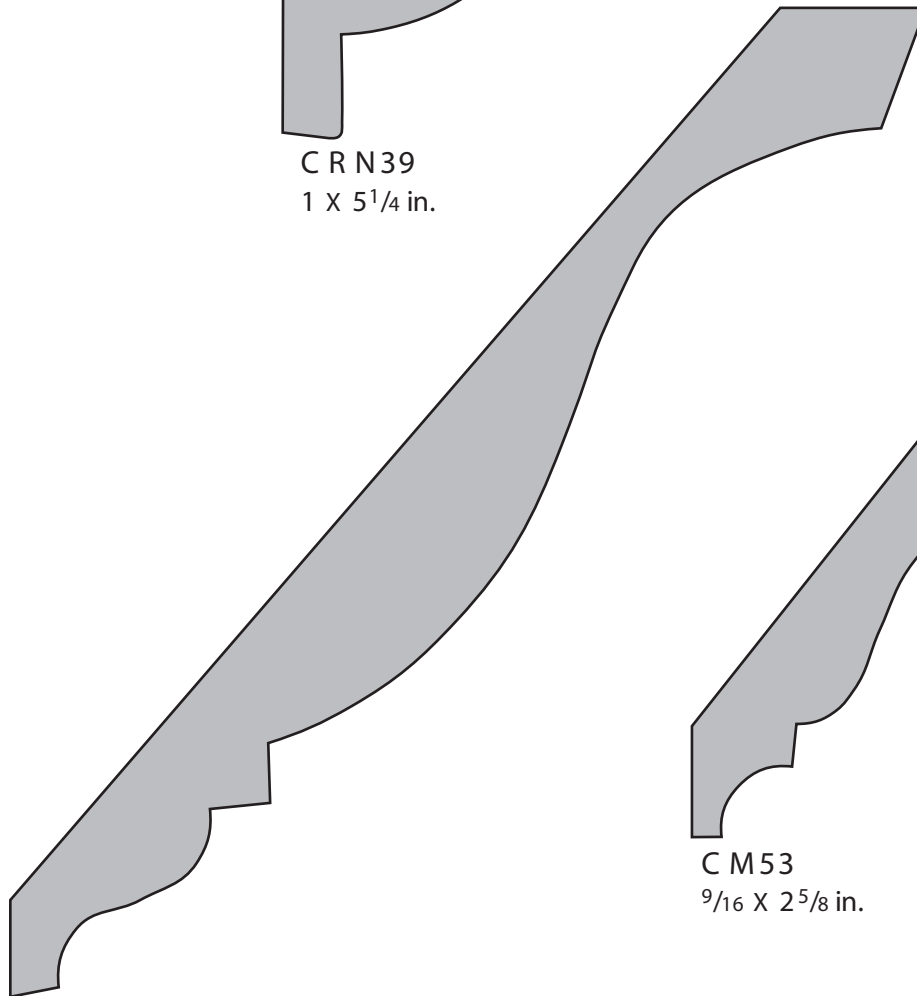

CM70(COX)  
3/4 X 7 1/4 in.

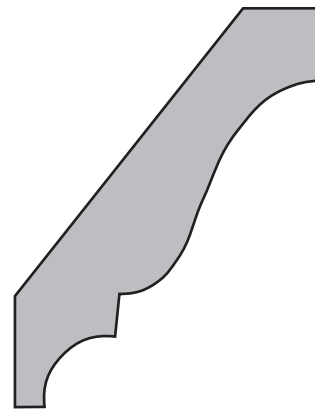

CM53  
9/16 X 2 5/8 in.



# CROWN

MOULDINGS.CC  
FLEXIBLE MOULDING

Many more profiles available, call 888-883-3113 \* Fax 305-675-3738

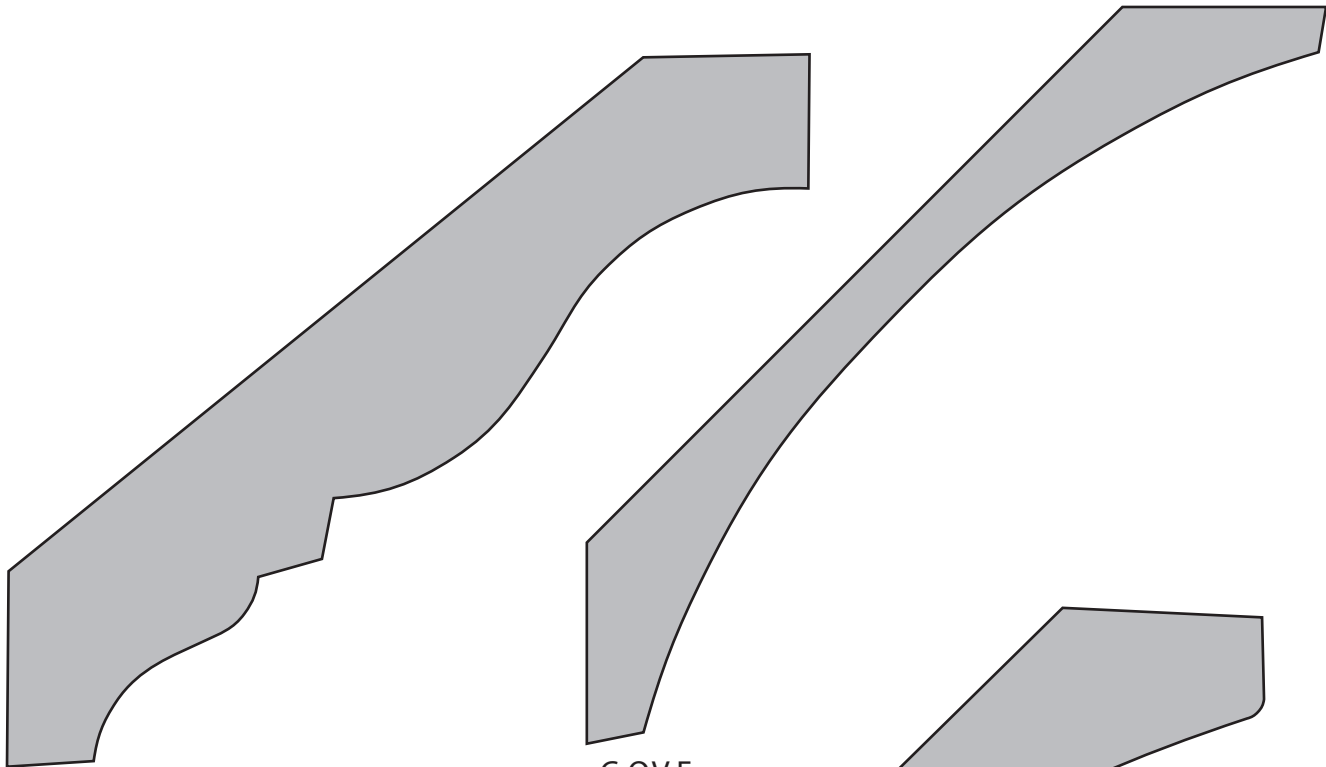

MTV 629  
1 X 5<sup>3</sup>/<sub>4</sub> in.

COVE  
9/16 X 5<sup>1</sup>/<sub>4</sub> in.

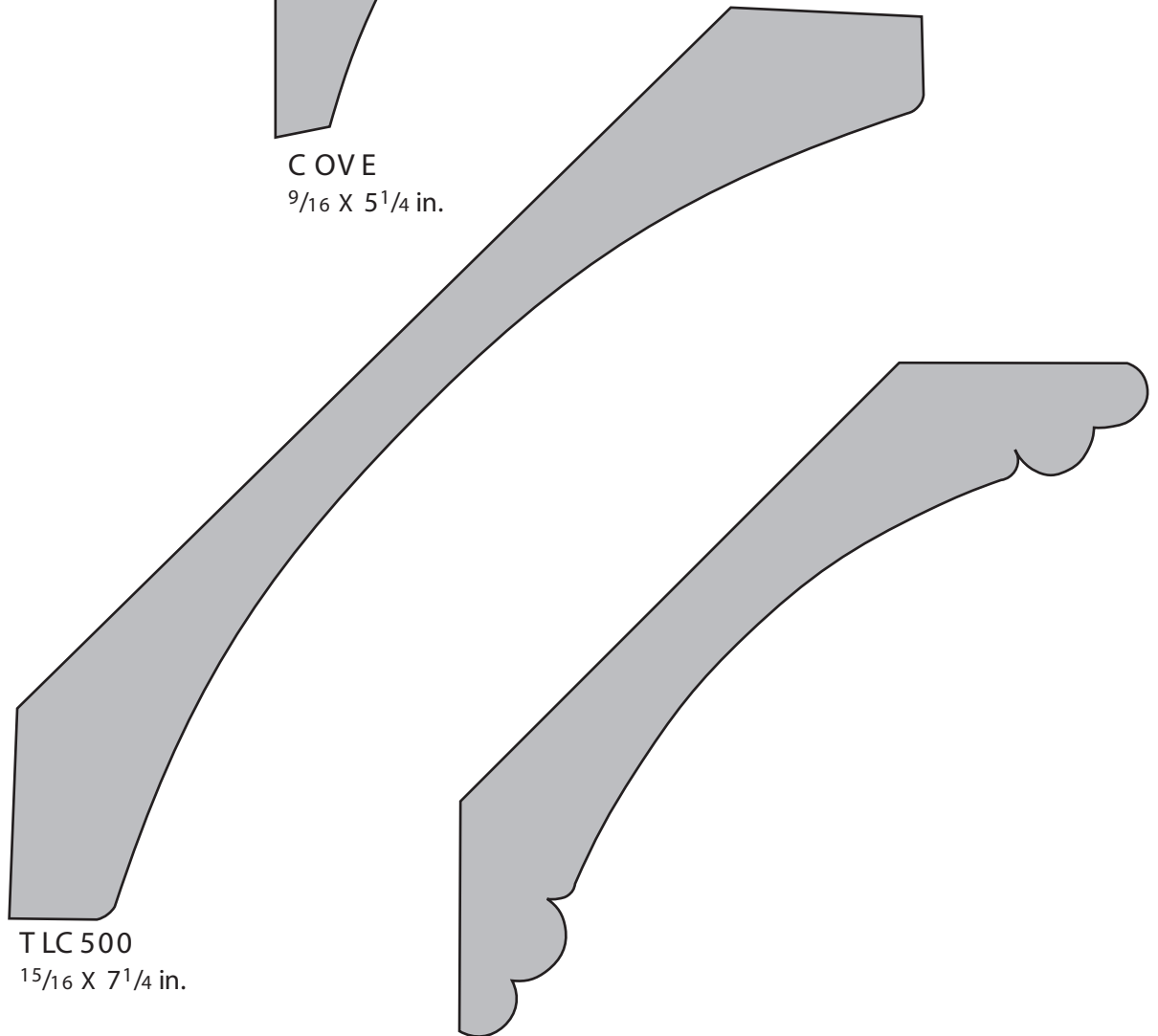

TLC 500  
1<sup>5</sup>/<sub>16</sub> X 7<sup>1</sup>/<sub>4</sub> in.

R B C C M 525  
1 X 5<sup>1</sup>/<sub>4</sub> in.

# CROWN

MOULDINGS.CC  
FLEXIBLE MOULDING

Many more profiles available, call 888-883-3113 \* Fax 305-675-3738

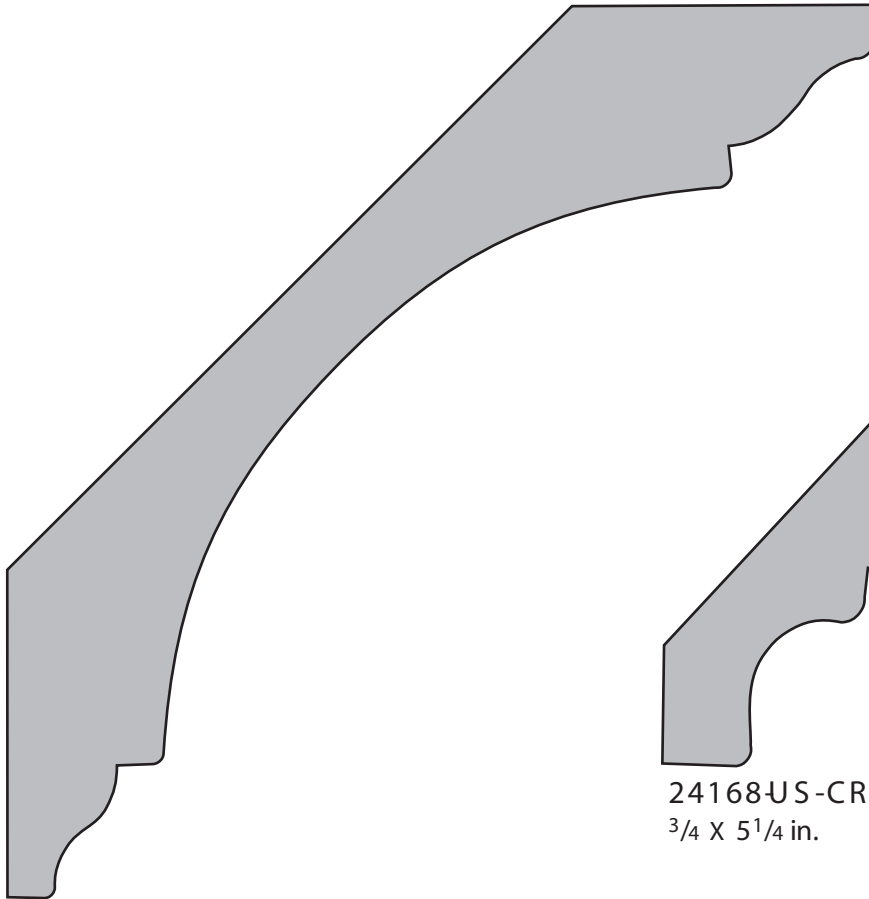

CBM1554  
1<sup>1</sup>/<sub>4</sub> X 6<sup>1</sup>/<sub>2</sub> in.

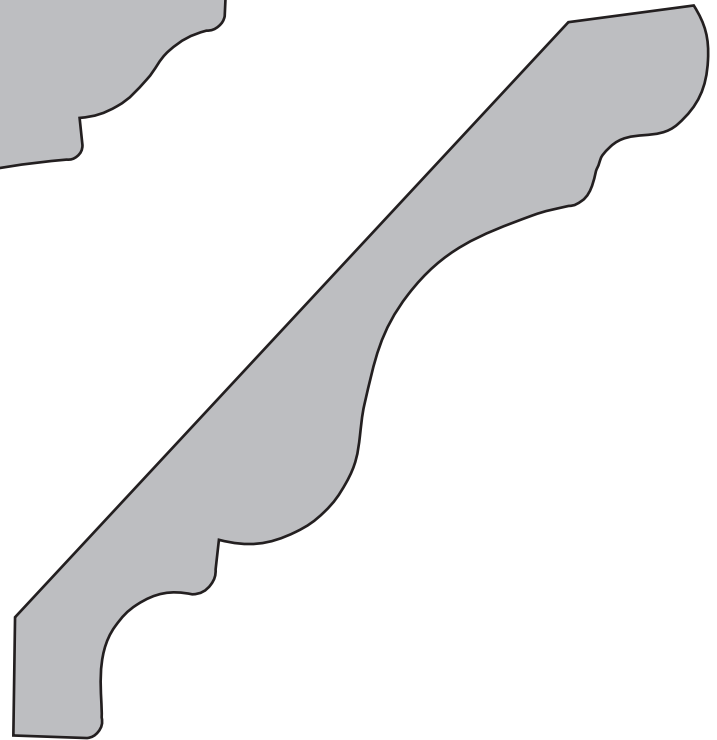

24168-US-CR  
3<sup>3</sup>/<sub>4</sub> X 5<sup>1</sup>/<sub>4</sub> in.

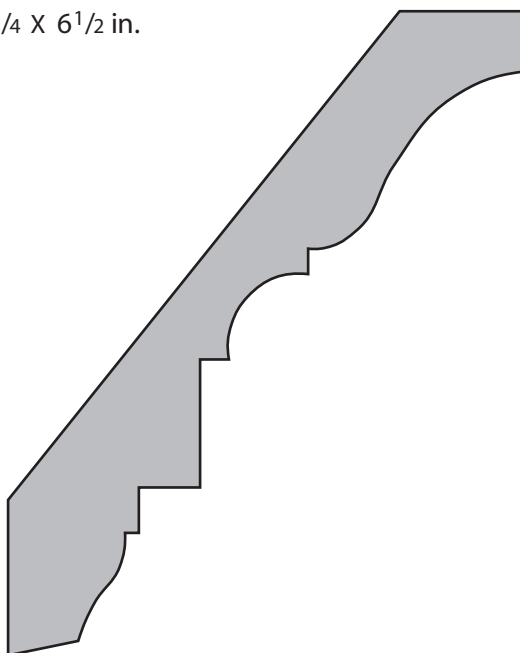

9 DENTIL  
1<sup>1</sup>/<sub>16</sub> X 4<sup>1</sup>/<sub>4</sub> in.

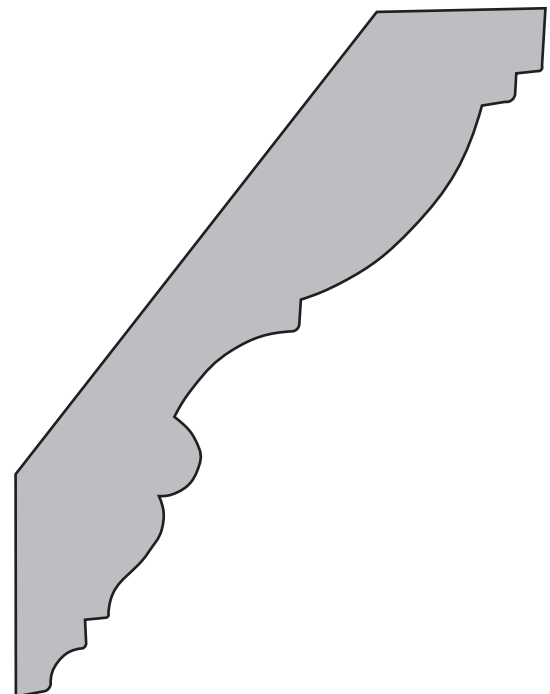

S M712  
7<sup>7</sup>/<sub>8</sub> X 4<sup>1</sup>/<sub>2</sub> in.

# CROWN

MOULDINGS.CC  
FLEXIBLE MOULDING

Many more profiles available, call 888-883-3113 \* Fax 305-675-3738

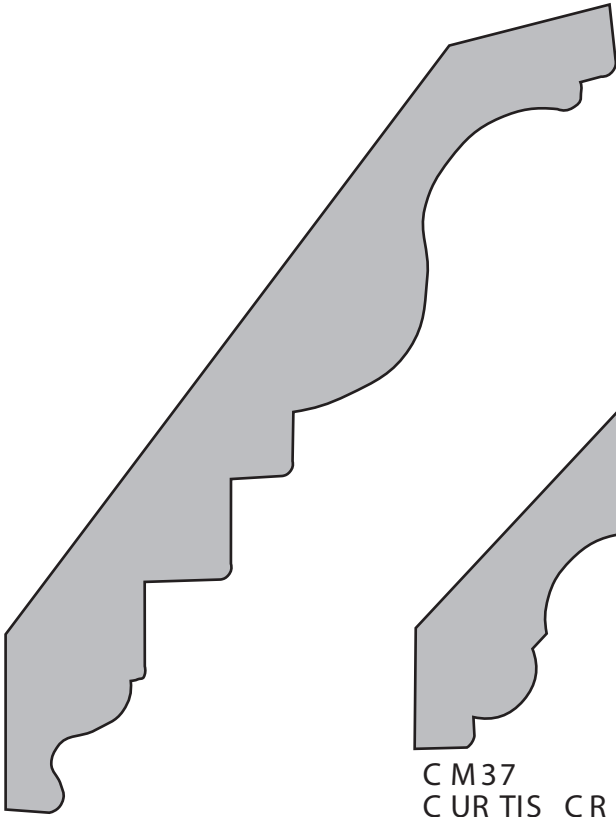

C M 549  
3/4 X 5 1/4 in.

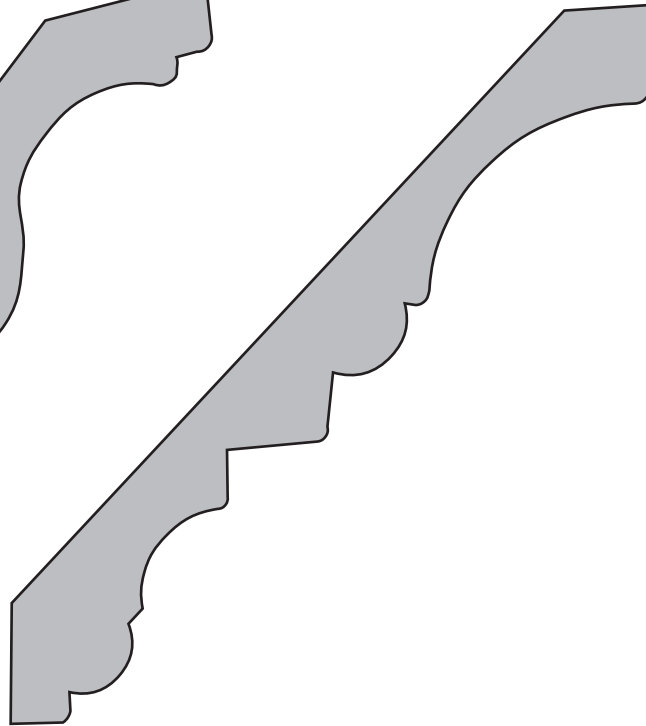

C M 37  
C U R T I S C R O W N  
1 1/16 X 5 1/16 in.

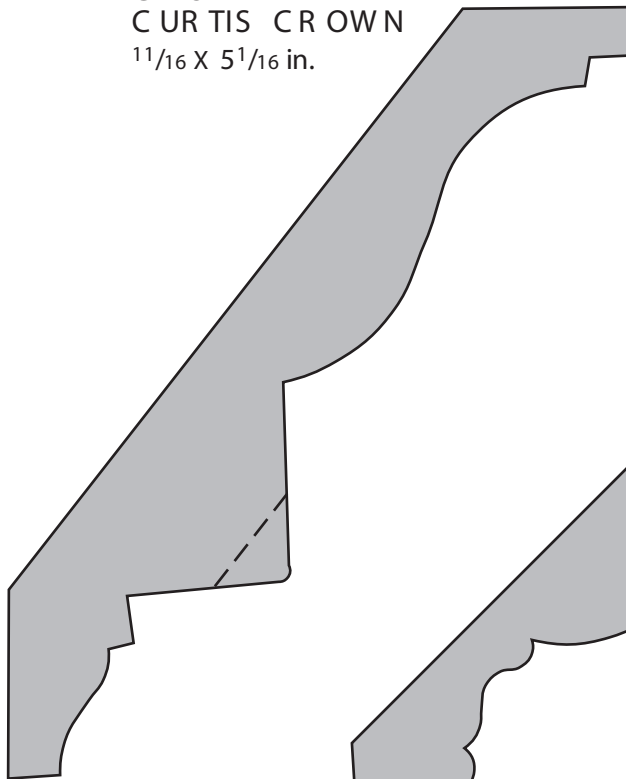

S M I T H D E N T I L C R N  
1 3/16 X 5 5/16 in.

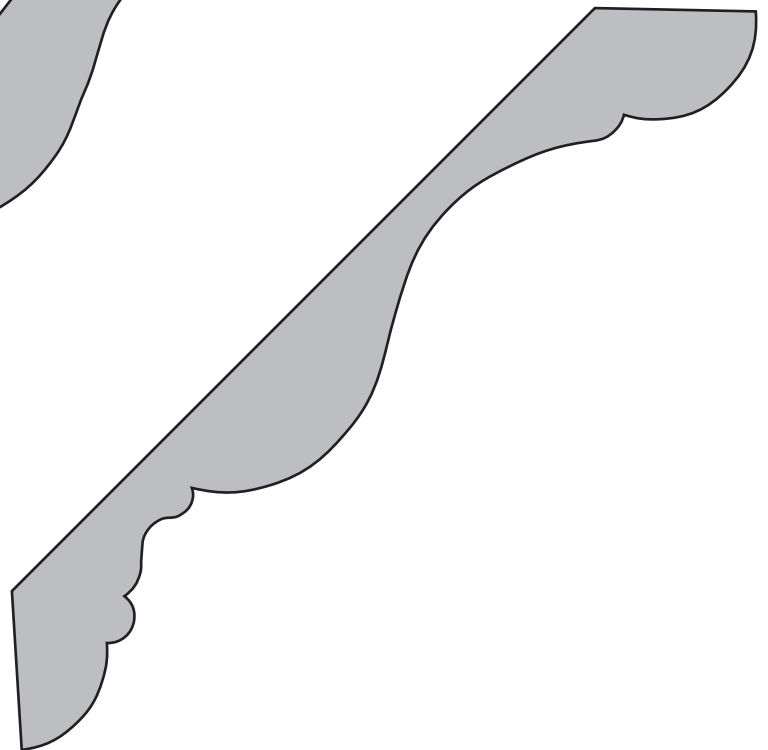

S M 1157  
3/4 X 5 3/8 in.

# CROWN

Many more profiles available, call 888-883-3113 \* Fax 305-675-3738

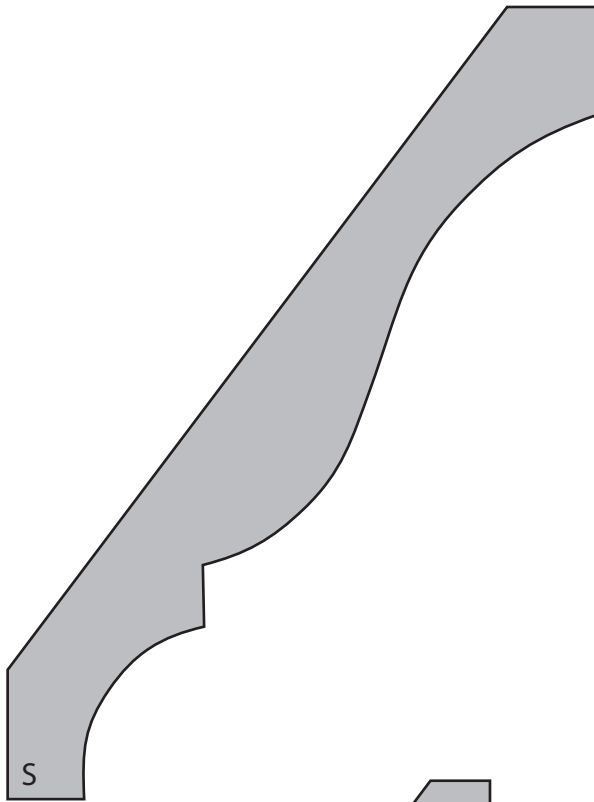

C M 45 (1-1/8" Cove)  
1 1/16 X 5 1/4 in.

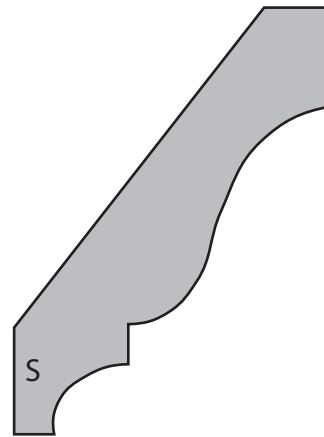

C M 52  
9/16 X 2 3/4 in.



C M 47  
9/16 X 4 5/8 in.

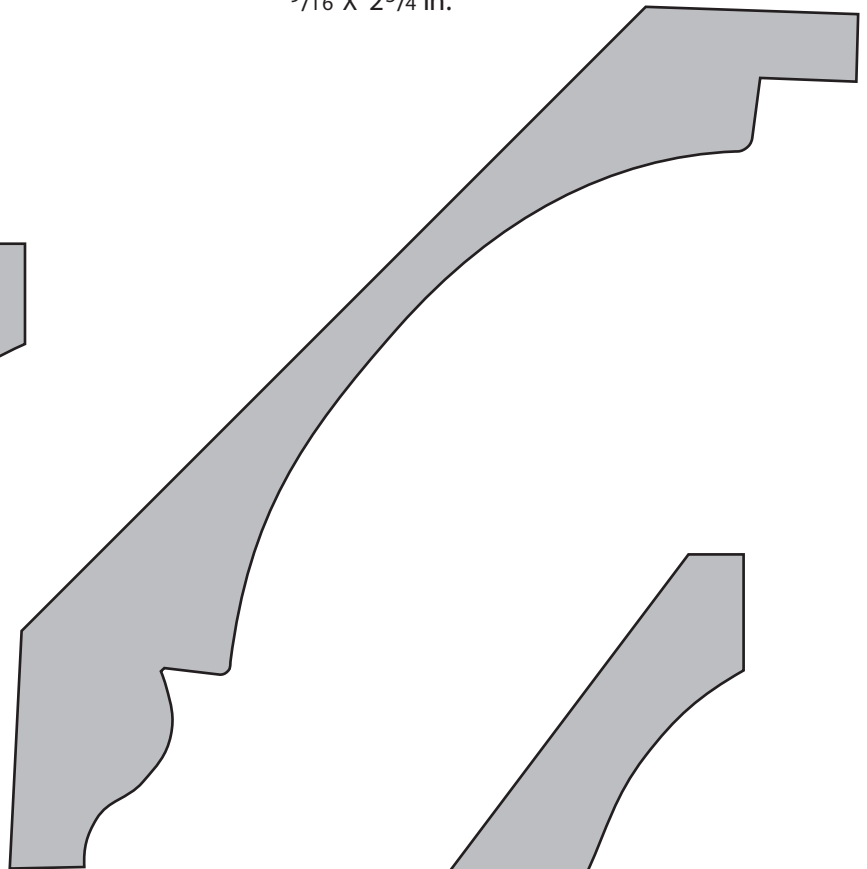

S M 1160  
1 3/4 X 6 1/4 in.

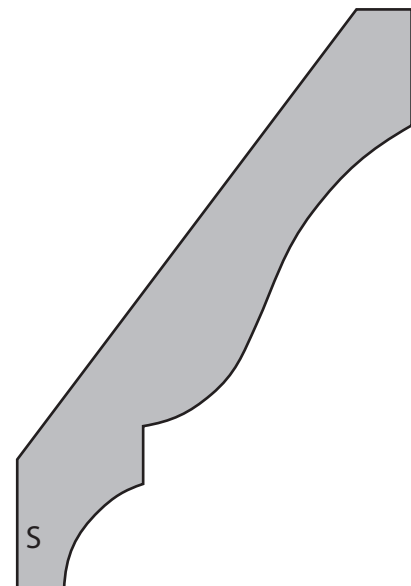

C M 49  
9/16 X 3 5/8 in.

# CROWN

MOULDINGS.CC  
FLEXIBLE MOULDING

Many more profiles available, call 888-883-3113 \* Fax 305-675-3738

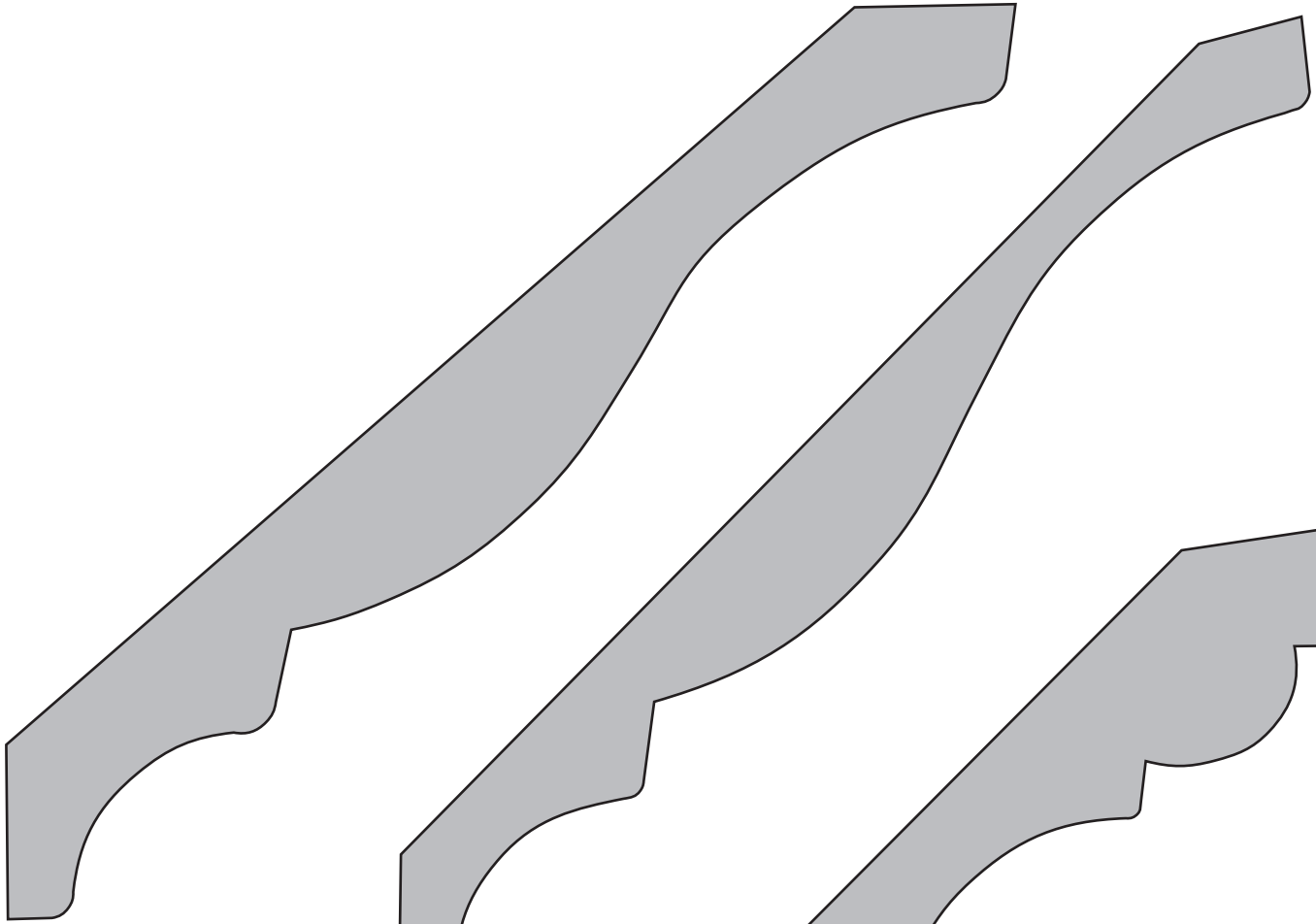

AH 41  
7/8 X 7 in.

7 1/4 MDF  
9/16 X 7 1/4 in.

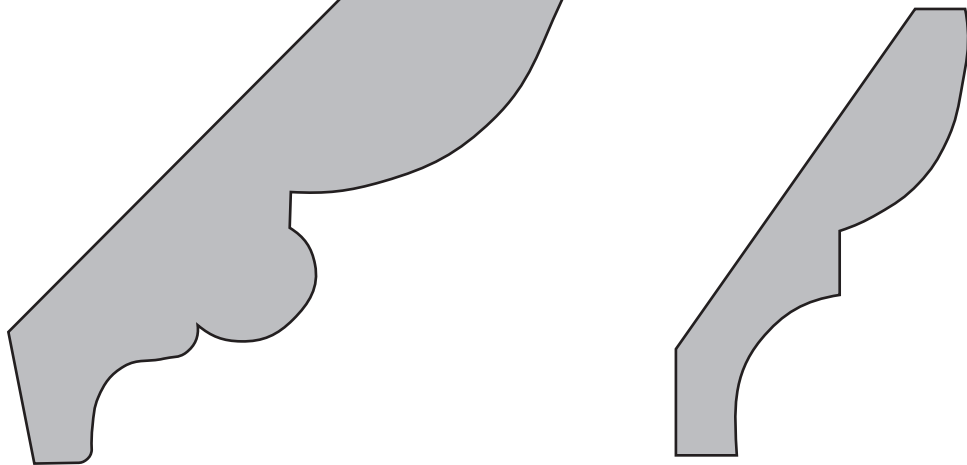

USL 42  
1 X 7 1/4 in.

CM70  
9/16 X 2 3/4 in.

# CROWN

MOULDINGS.CC  
FLEXIBLE MOULDING

Many more profiles available, call 888-883-3113 \* Fax 305-675-3738

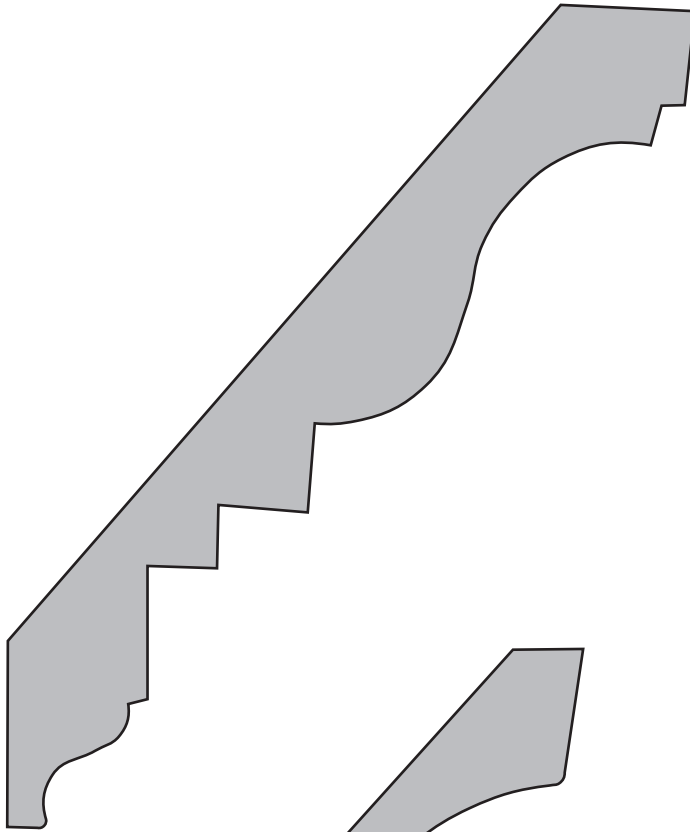

MCM 20-5  
 $\frac{3}{4}$  X  $5\frac{1}{2}$  in.

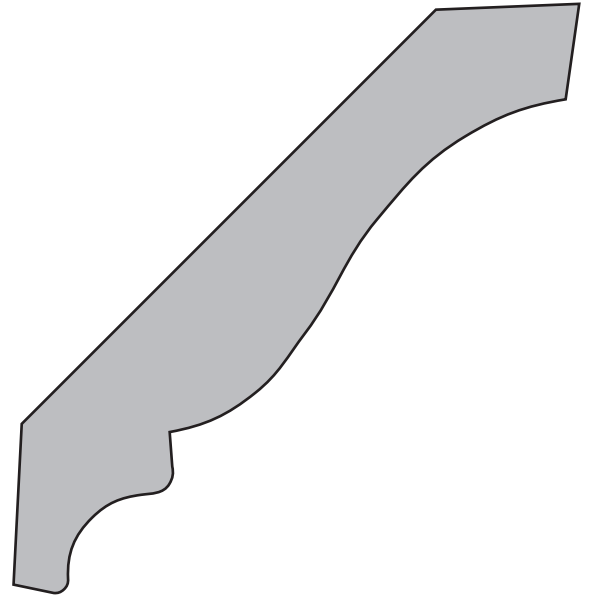

C OX 48  
 $\frac{3}{4}$  X  $4\frac{1}{4}$  in.

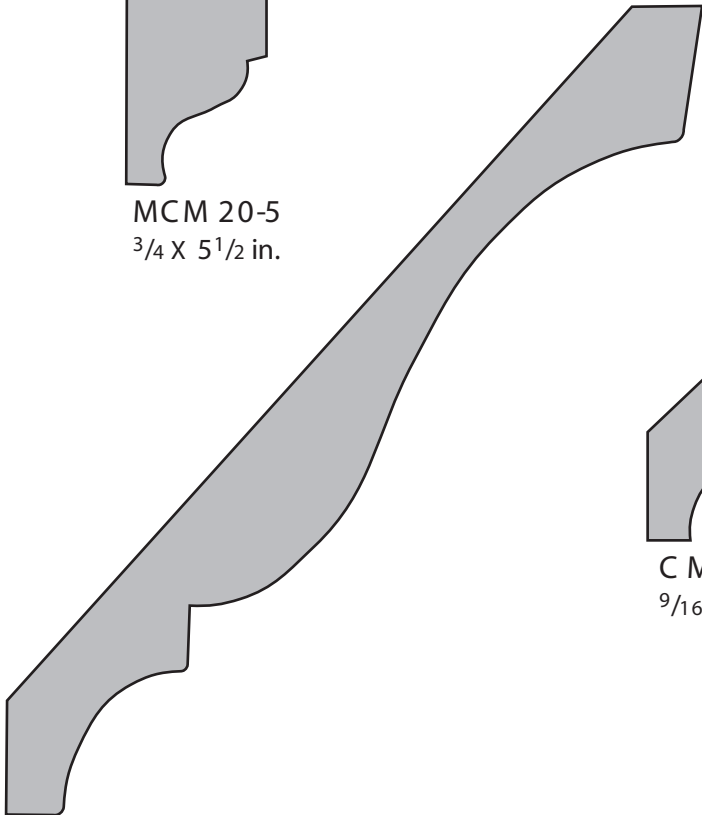

C M 17  
 $1\frac{1}{16}$  X  $5\frac{5}{8}$  in.

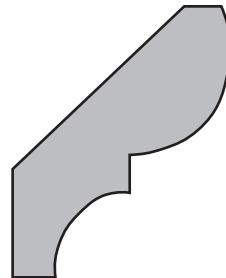

C M 74  
 $\frac{9}{16}$  X  $1\frac{3}{4}$  in.

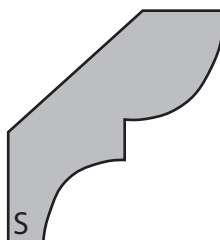

C M 75  
 $\frac{9}{16}$  X  $1\frac{5}{8}$  in.

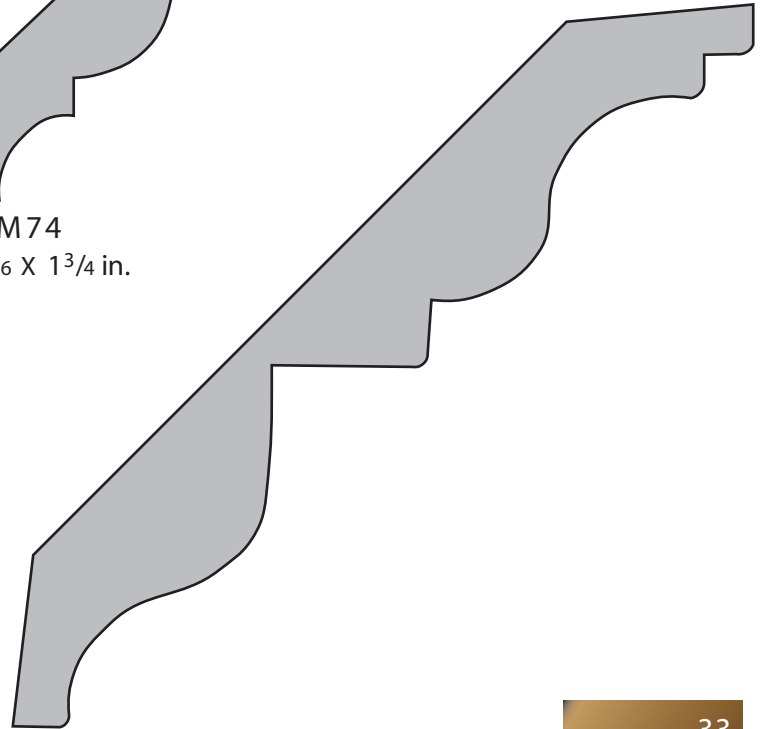

C M 49L  
 $\frac{3}{4}$  X  $5\frac{1}{4}$  in.

# CROWN BACKER

MOULDINGS.CC  
FLEXIBLE MOULDING

Many more profiles available, call 888-883-3113 \* Fax 305-675-3738

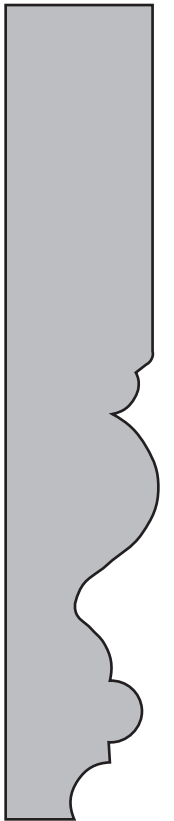

S M4008  
3/4 X 4 1/4 in.

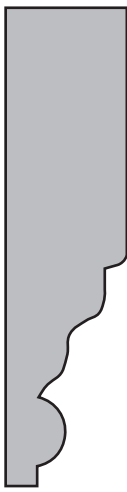

C RB250  
5/8 X 2 1/2 in.



AH19  
5/8 X 4 15/16 in.



C M2  
1 1/16 X 2 1/2 in.

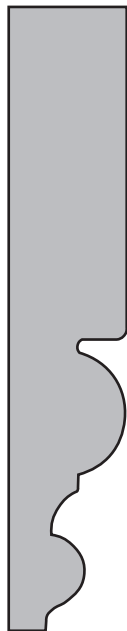

WINDSOR  
5/8 X 3 1/4 in.

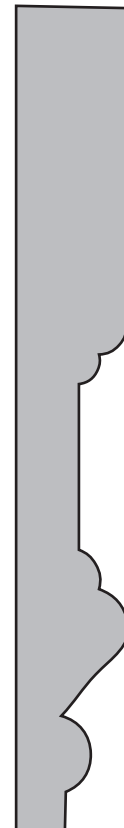

1701  
5/8 X 4 5/16 in.

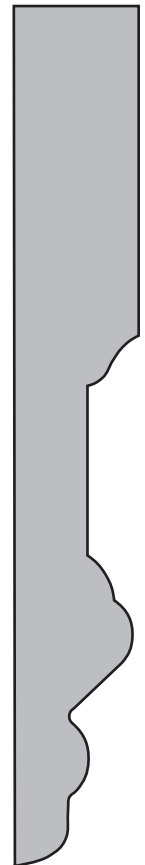

BR CROWN  
ENHANCE R  
5/8 X 4 1/2 in.

# BASE

MOULDINGS.CC  
FLEXIBLE MOULDING

Many more profiles available, call 888-883-3113 \* Fax 305-675-3738

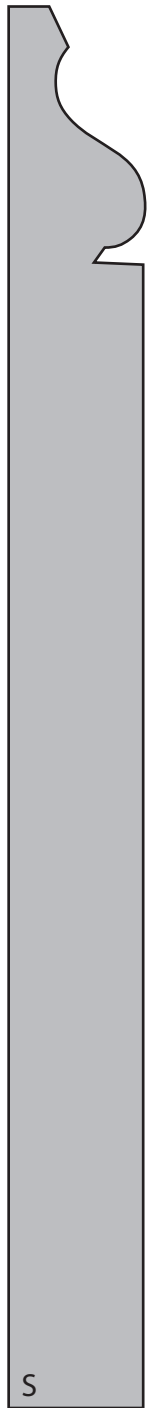

C M 810  
5/8 X 7 1/4 in.



C M 618  
9/16 X 5 1/4 in.



C M 710  
9/16 X 4 1/4 in.



C M 663  
9/16 X 3 1/4 in.



B CB 500  
5/8 X 5 1/4 in.  
Also Available:  
B CB 300  
5/8 X 3 1/4 in.  
B CB 400  
5/8 X 4 1/4 in.  
B CB 700  
5/8 X 7 1/4 in.  
B CB 925  
3/4 X 9 1/4 in.

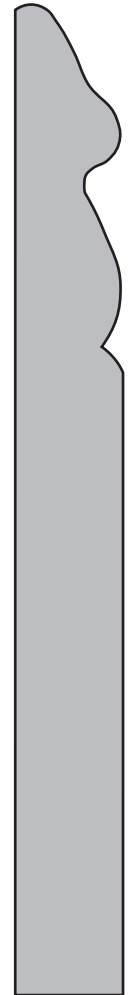

MS 5180  
9/16 X 5 1/4 in.



# BASE

MOULDINGS.CC  
FLEXIBLE MOULDING

Many more profiles available, call 888-883-3113 \* Fax 305-675-3738



612  
 $\frac{9}{16}$  X  $6 \frac{9}{16}$  in.

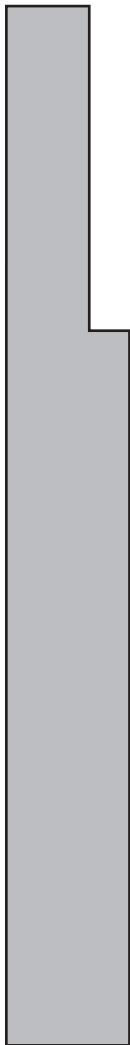

S M97  
 $\frac{3}{4}$  X  $5 \frac{1}{2}$  in.



S  
C M610  
 $\frac{9}{16}$  X  $5 \frac{1}{4}$  in.



S  
C M623  
 $\frac{9}{16}$  X  $3 \frac{1}{4}$  in.



C M753  
 $\frac{9}{16}$  X  $3 \frac{1}{4}$  in.  
Also Available:  
C M750  
 $\frac{9}{16}$  X  $4 \frac{1}{4}$  in.  
C M750W  
 $\frac{9}{16}$  X  $5 \frac{1}{4}$  in.

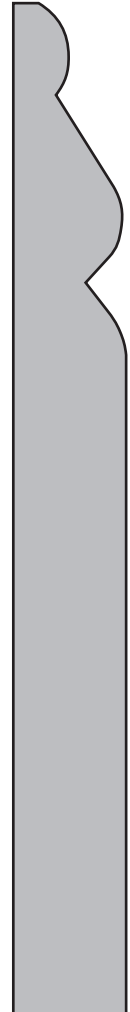

C M218  
 $\frac{9}{16}$  X  $5 \frac{1}{4}$  in.

# BASE

MOULDINGS.CC  
FLEXIBLE MOULDING

Many more profiles available, call 888-883-3113 \* Fax 305-675-3738

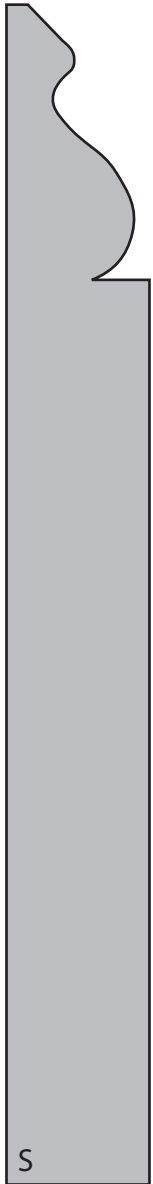

S

C M616  
 $1\frac{1}{16}$  X  $6\frac{1}{8}$  in.



TWPB  
 $1\frac{1}{16}$  X  $5\frac{1}{4}$  in.



MDF714  
 $\frac{5}{8}$  X  $7\frac{1}{4}$  in.



BBJ725  
 $\frac{3}{4}$  X  $7\frac{1}{4}$  in.

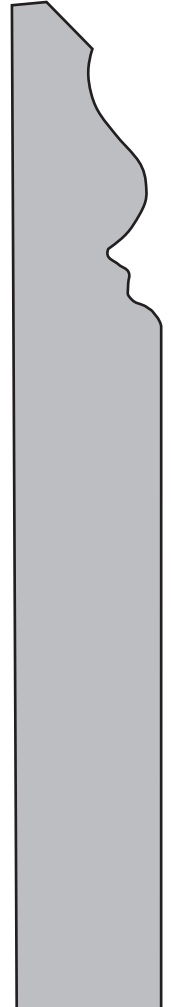

BBJ525  
 $\frac{3}{4}$  X  $5\frac{1}{4}$  in.  
Also Available:  
BBJ325  
 $\frac{3}{4}$  X  $3\frac{1}{4}$  in.  
BBJ425  
 $\frac{3}{4}$  X  $4\frac{1}{4}$  in.

Many more profiles available, call 888-883-3113 \* Fax 305-675-3738

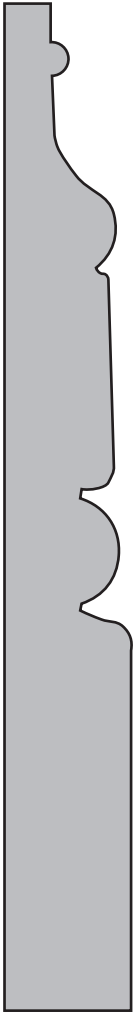

B LB 525  
5/8 X 5 1/4 in.  
Also Available:  
B LB 425  
5/8 X 4 1/4 in.  
B LB 725  
5/8 X 7 1/4 in.

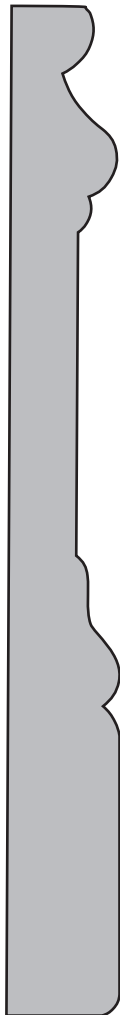

VICTORIAN B A S E  
9/16 X 5 1/4 in.



MBC 38-5  
3/4 X 5 1/4 in.



LDF B A 718  
5/8 X 7 1/8 in.

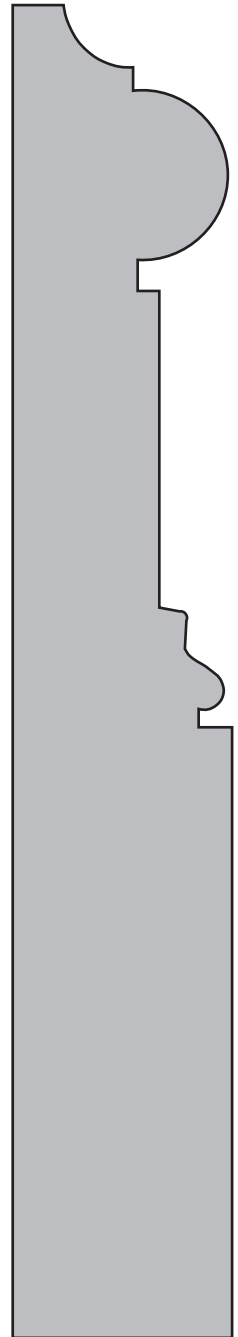

AH 617  
1 1/8 X 7 in.

# BASE CAPS

MOULDINGS.CC  
FLEXIBLE MOULDING

Many more profiles available, call 888-883-3113 \* Fax 305-675-3738

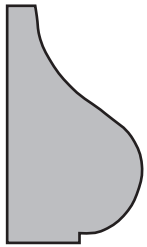

C M166  
1<sup>1</sup>/<sub>16</sub> X 1<sup>1</sup>/<sub>4</sub> in.



C M164  
1<sup>1</sup>/<sub>16</sub> X 1<sup>1</sup>/<sub>8</sub> in.

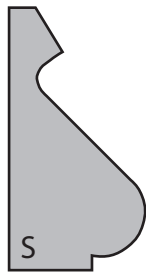

S  
C M163  
1<sup>1</sup>/<sub>16</sub> X 1<sup>3</sup>/<sub>8</sub> in.



S  
C M167  
1<sup>1</sup>/<sub>16</sub> X 1<sup>1</sup>/<sub>8</sub> in.



1201  
1<sup>1</sup>/<sub>16</sub> X 1<sup>1</sup>/<sub>4</sub> in.

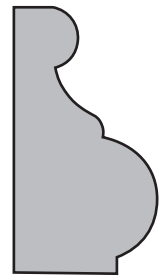

S M30  
3/4 X 1<sup>3</sup>/<sub>8</sub> in.

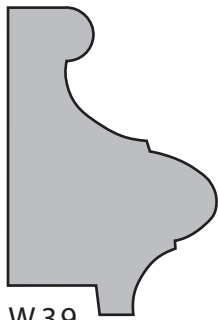

W39  
1<sup>1</sup>/<sub>8</sub> X 1<sup>1</sup>/<sub>2</sub> in.

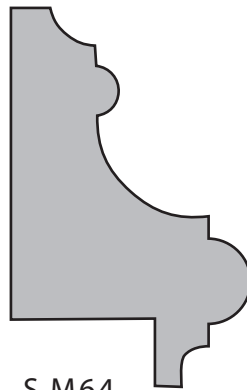

S M64  
1<sup>1</sup>/<sub>4</sub> X 2 in.

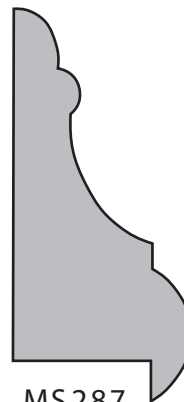

MS287  
1<sup>7</sup>/<sub>8</sub> X 2<sup>1</sup>/<sub>16</sub> in.



S M54  
5/8 X 1<sup>3</sup>/<sub>8</sub> in.

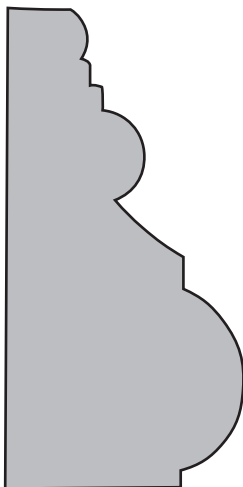

S M43  
1<sup>1</sup>/<sub>4</sub> X 2<sup>1</sup>/<sub>2</sub> in.

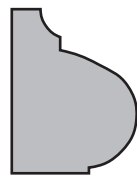

LWP 114  
1<sup>1</sup>/<sub>16</sub> X 7/8 in.

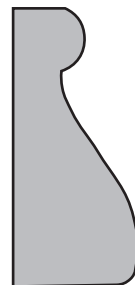

BCB 150  
1<sup>1</sup>/<sub>16</sub> X 1<sup>1</sup>/<sub>2</sub> in.

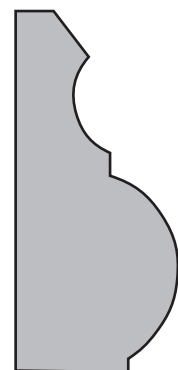

S M40  
7/8 X 1<sup>7</sup>/<sub>8</sub> in.

# CHAIR RAIL

MOULDINGS.CC  
FLEXIBLE MOULDING

Many more profiles available, call 888-883-3113 \* Fax 305-675-3738

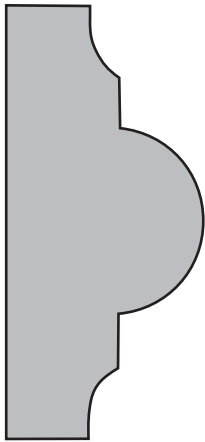

C 136  
1<sup>1</sup>/<sub>16</sub> X 2<sup>1</sup>/<sub>4</sub> in.

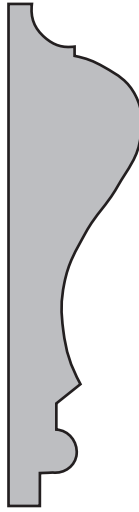

C M390  
1<sup>1</sup>/<sub>16</sub> X 2<sup>5</sup>/<sub>8</sub> in.

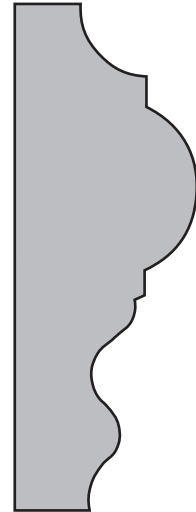

4  
1<sup>5</sup>/<sub>16</sub> X 2<sup>5</sup>/<sub>8</sub> in.

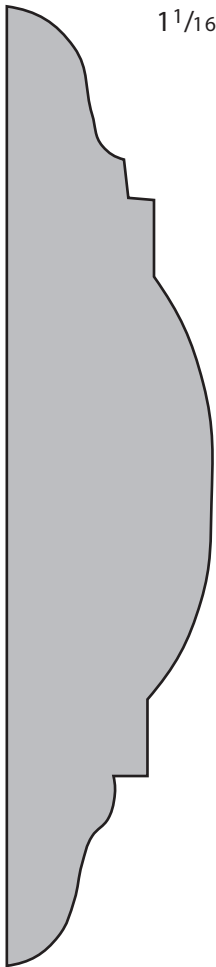

C R 560  
1 X 5 in.

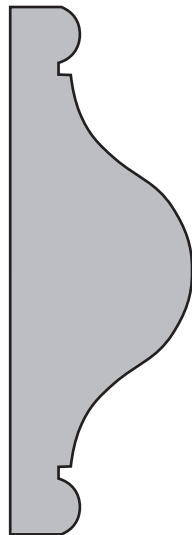

C M302  
1<sup>1</sup>/<sub>16</sub> X 2<sup>3</sup>/<sub>4</sub> in.

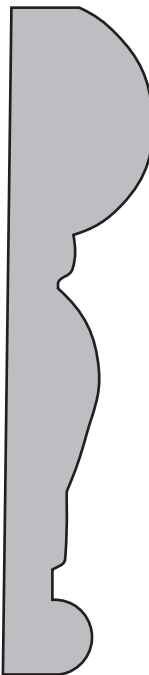

C R 290  
3/4 X 3<sup>1</sup>/<sub>2</sub> in.

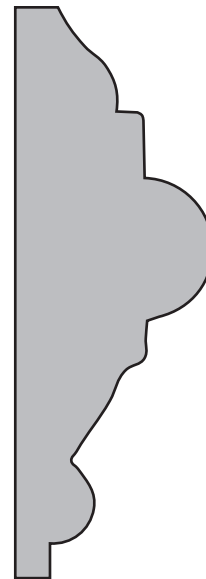

C RAL 333  
1 X 3 in.

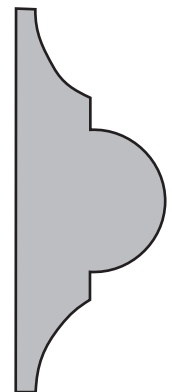

HH133  
3/4 X 2 in.

# CHAIR RAIL

MOULDINGS.CC  
FLEXIBLE MOULDING

Many more profiles available, call 888-883-3113 \* Fax 305-675-3738

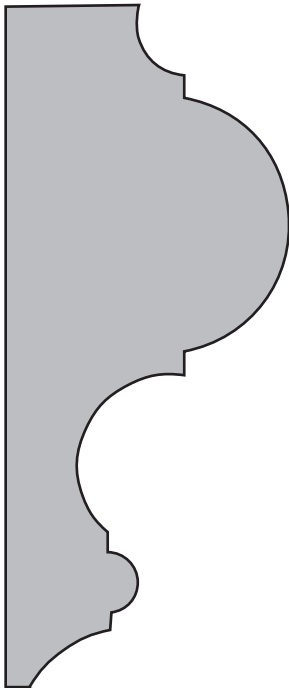

S M225  
1<sup>3</sup>/<sub>8</sub> X 3<sup>5</sup>/<sub>8</sub> in.

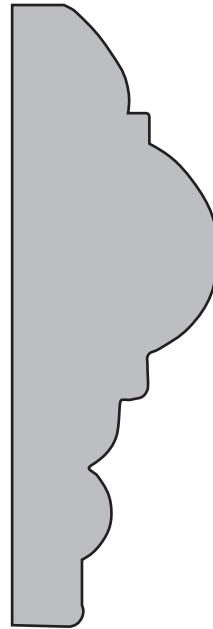

MD4  
1<sup>1</sup>/<sub>16</sub> X 3<sup>1</sup>/<sub>4</sub> in.

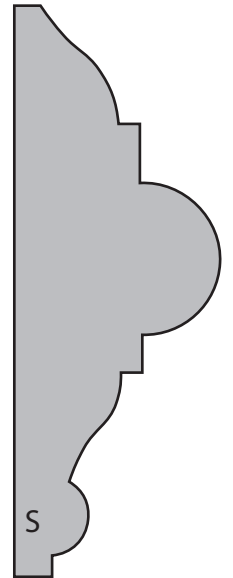

C M300  
1<sup>1</sup>/<sub>16</sub> X 3 in.

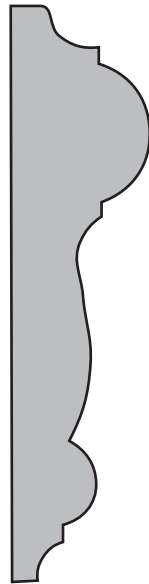

C M297  
1<sup>1</sup>/<sub>16</sub> X 3 in.

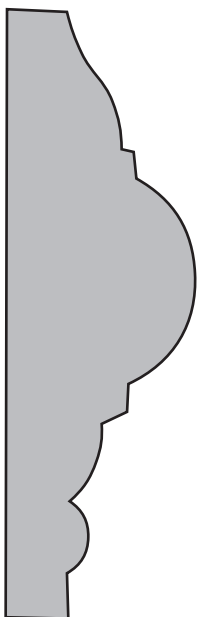

GP 200  
1 X 3<sup>1</sup>/<sub>4</sub> in.



C RA 350  
3/4 X 3<sup>1</sup>/<sub>2</sub> in.

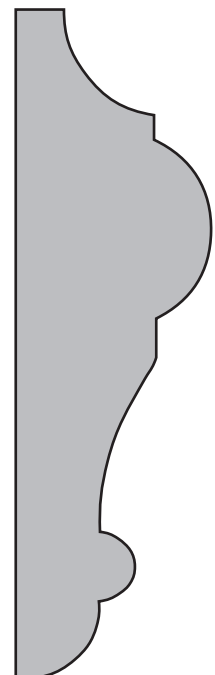

C M397  
1 X 3<sup>1</sup>/<sub>2</sub> in.

# CHAIR RAIL BACKER

MOULDINGS.CC  
FLEXIBLE MOULDING

Many more profiles available, call 888-883-3113 \* Fax 305-675-3738

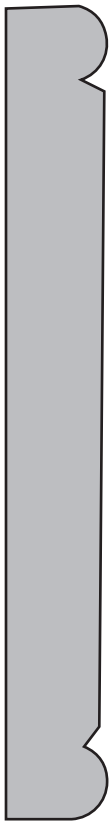

C M957  
1/2 X 4 1/4 in.

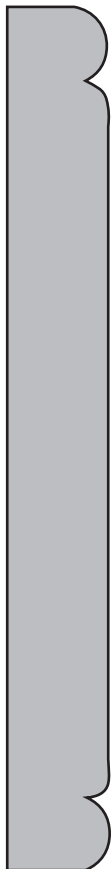

C M425 (C135)  
1/2 X 4 1/2 in.

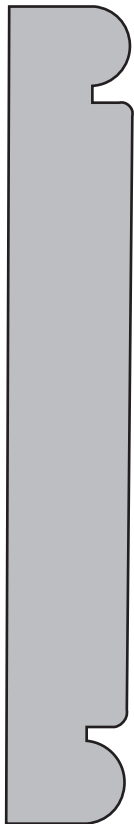

C RB 425  
3/4 X 4 1/4 in.



C M398  
1/2 X 5 1/4 in.



C M956  
7/16 X 4 1/4 in.



C RB 525  
3/4 X 5 1/2 in.



C M6  
7/16 X 4 1/2 in.

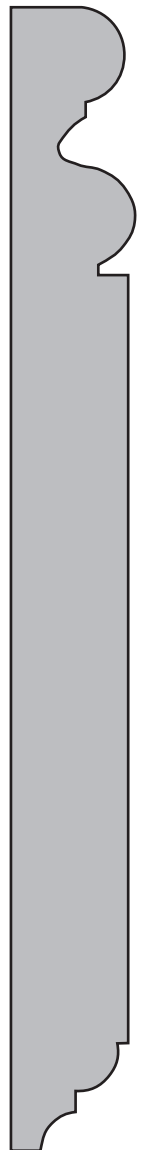

426  
5/8 X 6 in.

# PANEL MOULDING

MOULDINGS.CC  
FLEXIBLE MOULDING

Many more profiles available, call 888-883-3113 \* Fax 305-675-3738

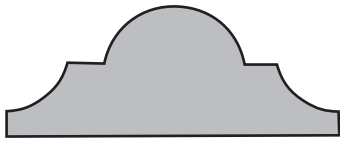

MPM20  
3/4 X 1 1/2 in.

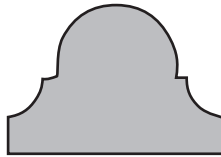

PM118  
3/4 X 1 in.

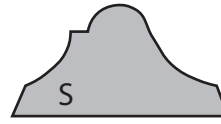

CM183  
9/16 X 1 1/8 in.

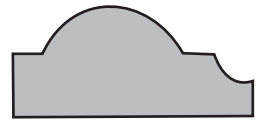

A9  
9/16 X 1 1/4 in.

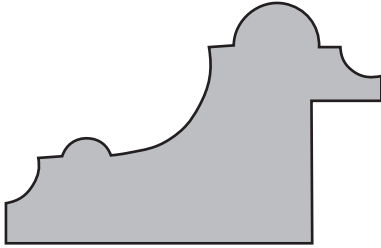

SM64  
1 1/4 X 2 in.



PM43  
15/16 X 2 1/8 in.

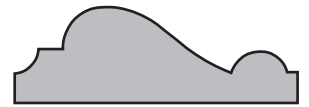

CM184  
1/2 X 1 1/2 in.

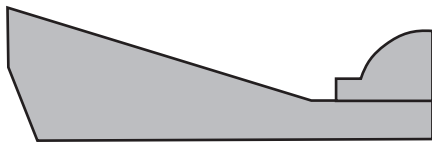

57  
1 1/16 X 2 1/4 in.

70  
3/8 X 1 1/2 in.

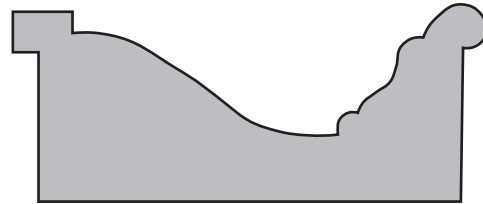

SM3514  
15/16 X 2 3/8 in.

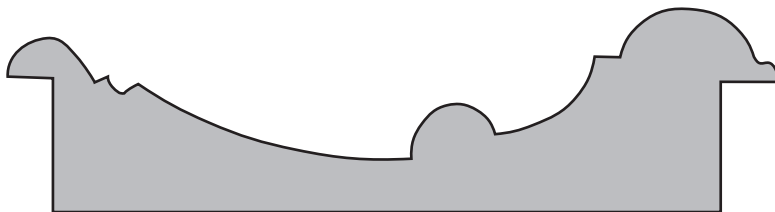

PM5126  
1 1/16 X 4 1/16 in.

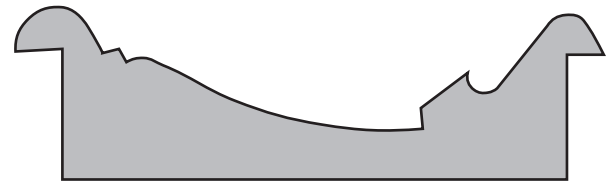

PM5127  
7/8 X 3 1/16 in.



C 42  
1 1/16 X 1/8 in.  
RABBETED  
Also Available:  
C42R 1/2  
C42R 3/4

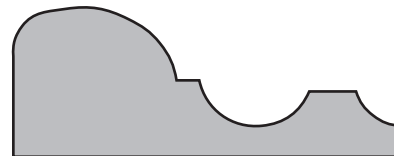

PM250  
3/4 X 2 in.  
RABBETED  
Also Available:  
PM250R 4  
1/2 in. R AB  
PM250R5  
3/4 in. R AB



Many more profiles available, call 888-883-3113 \* Fax 305-675-3738

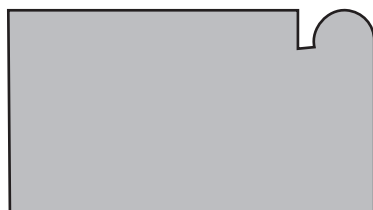

C M175  
1<sup>1</sup>/<sub>16</sub> X 2 in.

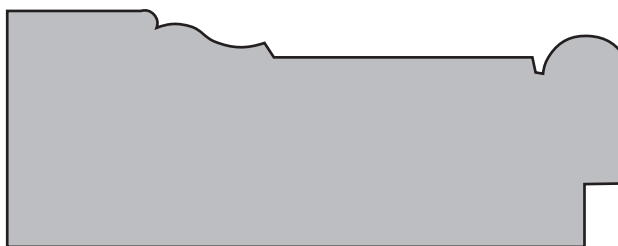

E C 181  
1<sup>1</sup>/<sub>4</sub> X 3<sup>1</sup>/<sub>4</sub> in.



W M179  
1<sup>1</sup>/<sub>4</sub> X 3<sup>1</sup>/<sub>4</sub> in.

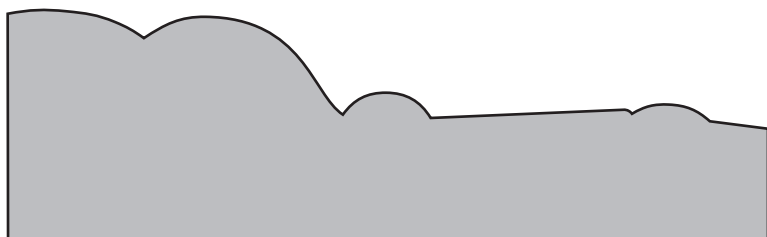

CONGRESSIONAL BMC (E C185)  
1<sup>1</sup>/<sub>4</sub> X 4 in.



C M180  
1<sup>1</sup>/<sub>4</sub> X 2 in.

# RAKES

Many more profiles available, call 888-883-3113 \* Fax 305-675-3738

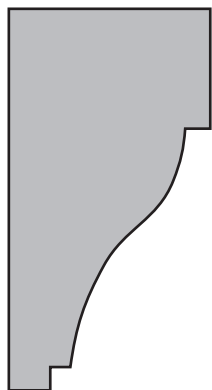

C M287  
1<sup>1</sup>/<sub>16</sub> X 2 in.

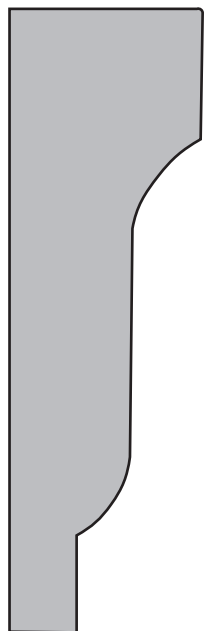

C M1206  
1 X 3<sup>1</sup>/<sub>16</sub> in.

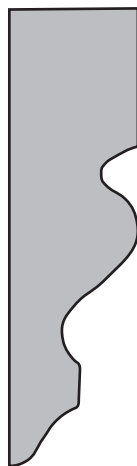

C M212  
5/8 X 2<sup>1</sup>/<sub>2</sub> in.

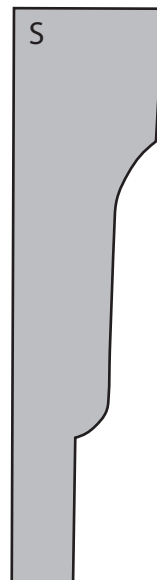

C M28  
3/4 X 3 in.



C M207  
1<sup>1</sup>/<sub>16</sub> X 2<sup>1</sup>/<sub>2</sub> in.

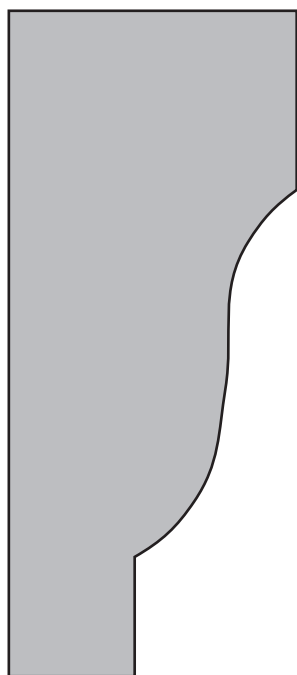

C M29  
1<sup>1</sup>/<sub>2</sub> X 3<sup>1</sup>/<sub>2</sub> in.

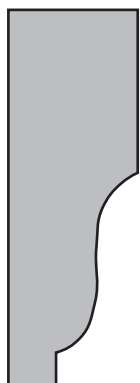

C M209  
1<sup>1</sup>/<sub>16</sub> X 2 in.



C M210  
5/8 X 1<sup>5</sup>/<sub>8</sub> in.

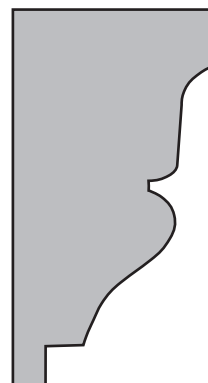

S M41(W M286)  
1<sup>1</sup>/<sub>16</sub> X 2 in.

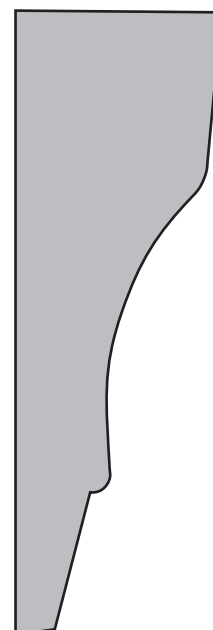

WP 207  
1<sup>1</sup>/<sub>8</sub> X 3<sup>1</sup>/<sub>4</sub> in.



LWP 286  
1<sup>1</sup>/<sub>16</sub> X 2 in.

# VARIATIONS

MOULDINGS.CC  
FLEXIBLE MOULDING

Many more profiles available, call 888-883-3113 \* Fax 305-675-3738

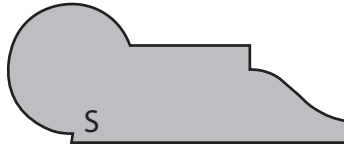

CM273  
1<sup>11</sup>/<sub>16</sub> X 1<sup>3</sup>/<sub>4</sub> in.

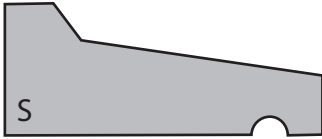

CM197  
1<sup>11</sup>/<sub>16</sub> X 1<sup>5</sup>/<sub>8</sub> in.



CM988  
3/8 X 1<sup>1</sup>/<sub>2</sub> in.  
Also Available:  
CM987  
3/8 X 2 in.



CM137  
9/16 X 1/4 in.



HR150  
1<sup>1</sup>/<sub>2</sub> X 3/4 in.



HR100  
1 X 1/2 in.



CM131  
(Ogee S hoe)  
7/16 X 3/4 in.

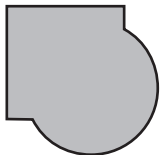

PENCIL MOULD  
5/8 X 5/8 in.

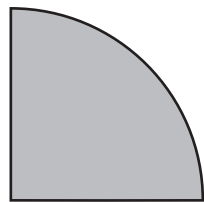

1 in. QR.  
1 in. X 1 in.

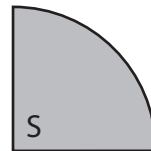

CM105  
3/4 X 3/4 in.

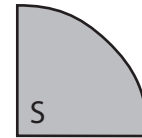

CM106  
1<sup>1</sup>/<sub>16</sub> X 1<sup>1</sup>/<sub>16</sub> in.



CM936  
3/8 X 1<sup>3</sup>/<sub>8</sub> in.  
Also Available:  
CM937  
3/8 X 1<sup>1</sup>/<sub>4</sub> in.



CM940  
7/16 X 7/8 in.  
Also Available:  
CM941A  
7/16 X 5/8 in.  
CM941  
7/16 X 3/4 in.



CM127  
7/16 X 1<sup>1</sup>/<sub>16</sub> in.



CM126  
1/2 X 3/4 in.

# VARIATIONS

Many more profiles available, call 888-883-3113 \* Fax 305-675-3738

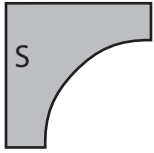

CM93  
3/4 X 3/4 in.

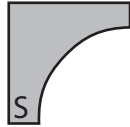

CM100  
1<sup>1</sup>/<sub>16</sub> X 1<sup>1</sup>/<sub>16</sub> in.



CM101  
1/2 X 1/2 in.



SCOTIA  
WM1075  
1/2 X 3/4 in.

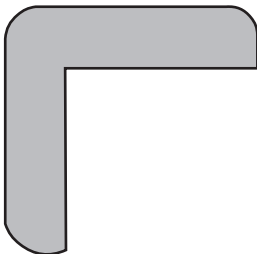

CM204  
1<sup>5</sup>/<sub>16</sub> X 1<sup>5</sup>/<sub>16</sub> in.

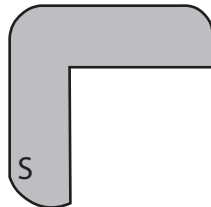

CM205  
1<sup>1</sup>/<sub>16</sub> X 1<sup>1</sup>/<sub>16</sub> in.

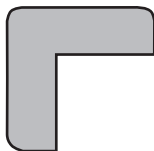

CM206  
3/4 X 3/4 in.



FLEX JAMB	
496	3/4 X 4 <sup>9</sup> / <sub>16</sub> in.
696	3/4 X 6 <sup>9</sup> / <sub>16</sub> in.
EASED EDGE	

S 4S	
1 X 2	3/4 X 1 <sup>1</sup> / <sub>2</sub> in.
1 X 2 NET	3/4 X 2 in.
CMXJ	3/4 X 3 <sup>1</sup> / <sub>16</sub> in.
1 x 4	3/4 X 3 <sup>1</sup> / <sub>2</sub> in.
1 x 6	3/4 X 5 <sup>1</sup> / <sub>2</sub> in.
1 x 8	3/4 X 7 <sup>1</sup> / <sub>2</sub> in.
1 x 10	3/4 X 9 <sup>1</sup> / <sub>4</sub> in.
1 x 12	3/4 X 11 <sup>1</sup> / <sub>4</sub> in.
5/4 x 4	1 X 3 <sup>1</sup> / <sub>2</sub> in.
5/4 x 6	1 X 5 <sup>1</sup> / <sub>2</sub> in.
5/4 x 8	1 X 7 <sup>1</sup> / <sub>2</sub> in.
5/4 x 10	1 X 9 <sup>1</sup> / <sub>4</sub> in.
5/4 x 12	1 X 11 <sup>1</sup> / <sub>4</sub> in.

Many more profiles available, call 888-883-3113 \* Fax 305-675-3738

PAGE 5-CASINGS	PAGE 10	PAGE 17	PAGE 24
CM356	LSM2060	CBG300	SM1136
CM366	BM1188	SM47	BBS725
CM445	CN400	PT312	CCM725
CM444	CBG400	SM2	CCM525(NS)
CM376	CRC350	CM466	CCM425(NS)
CM444A	CRC425	PRE SIDE NTIAL	BBS111
CM470	PAGE 11	PAGE 18	PAGE 25
CM442	CGA425	PLARGE HOWE	SM21
CM1	COXCOMB	TMMH	EC36
CM97	NH358	DELTA HOWE	SM38
PAGE 6	WM371	CKN535	CM725L
CCC525	CKN350	CM10	CM525L
C606R	CM361	CA350	PAGE 26
SM75	SM83	CA525	SM32
SM85	PAGE 12	MS11	CM375L
C606F	SM80	PAGE 19-BACK	RB4
SM5806	CJF425	BANDS	BM51245
PAGE 7	LWM97	C282	RB7
C600R	C425	CM809	PAGE 27
CM14R	MIS SJENNY	4048USBB	AH61
CM14F	CAG425	97BB	CRN39
PT338F	PAGE 13	SM68	CM70(COX)
PT338R	CM433	CM142	CM53
1002	CM473	4048	PAGE 28
1002M	CAS30	C281	MTV629
CNF312	CM452	3436BB	COVE
CCC350	SM2050	SM2513	TLC500
SM8	BM995	PAGE 20	RBCCM525
PAGE 8	SM5701	SM2501-2	PAGE 29
SM12	PAGE 14	SM2501	CBM1554
CM445A	CAM350	CM280	24168-US-CR
CFC214	BM1455	BB200	9DENTIL
CFC315(NS)	C352	SM2510	SM712
CFC425(NS)	RBI SPR3	SM2511-2	PAGE 30
24112PCA	BM255	SM2511	CM549
2814	CAM400	CM289	CM37
CM460	SM84	CRC150	SMITH DENTIL CRN
CM371	PAGE 15	GP281	SM1157
MD2	RBI208	CM281	PAGE 31
NH234	CTE350	PAGE 21-CROWN	CM45(1-1/8" Cove)
PAGE 9	CM683	SM27	CM52
SM7	TM1	SM603	CM47
CM327	399	BM6	SM1160
CRK350	MS1661	SM29	CM49
PM719	SM2051	SM42	PAGE 32
WM351	CW1	PAGE 22	AH41
CBG275	PAGE 16	AH40	MS43
RIDOUT376	C351	CM48	USL42
CAS50	WM444	WM80	CM70
CKN425	LDFCA4	CM541	PAGE 33
	CKM234	COLONIAL COVE	MCM20-5
	SM82	PAGE 23	COX48
	EC490	SM81	CM17
		SM86(NS)	CM74
		RBCCM625	CM75
		TP41	CM49L
		CM449C	
		CM6449C(NS)	

(NS) = Not shown but available

Many more profiles available, call 888-883-3113 \* Fax 305-675-3738

PAGE 34-CROWN

BACKERS  
SM4008  
CRB250  
AH19  
CM2  
WINDSOR  
1701  
BR CROWN ENHANCER

PAGE 35-BASES

CM810  
CM618  
CM710  
BCB 500  
BCB 300(NS)  
BCB 400(NS)  
BCB 700(NS)  
BCB 925(NS)

MS 5180

CM663

PAGE 36

612

SM97

CM610

CM623

CM218

CM753

CM750(NS)

CM750W(NS)

PAGE 37

CM616

TWPB

MDF714

BBJ725

BBJ525

BBJ325(NS)

BBJ425(NS)

PAGE 38

BLB525

BLB425(NS)

BLB725(NS)

VICTORIAN BASE

MBC38-5

LDFBA718

AH617

PAGE 39BASE CAPS

CM166

CM164

CM163

CM167

1201

SM30

W39

SM64

MS287

SM54

SM43

LWP114

BCB150

SM40

PAGE 40CHAIR RAIL

C136

CM390

4

CR560

CM302

CR290

CRAL333

HH133

PAGE 4

SM225

MD4

CM300

GP200

CM297

CRA350

CM397

PAGE 42CHAIR RAIL BACKER

CM957

CRB425

CM956

CM6

CM425(C135)

CM398

CRB525

426

PAGE 43PANEL MOULDING

MPM20

PM118

CM183

A9

SM64

PM43

CM184

57,70

SM3514

PM5127

PM5126

C42

C42R<sup>1</sup>/<sub>2</sub>(NS)

C42R<sup>3</sup>/<sub>4</sub>(NS)

PM250

PM250R4(NS)

PM250R5(NS)

PAGE 44BRICK MOULDING

AH181

CM175

WM179

CONGRESSIONAL BMC

CM180

PAGE 45RAKES

CM287

CM1206

CM212

CM28

CM207

CM29

CM209

CM210

PAGE 45CONTINUED

SM41(WM286)

LWP286

WP207

PAGE 46VARIATIONS

CM273

CM197

CM137

CM988

CM987(NS)

HR150

HR100

CM131

PENCIL MOULD

1IN. QR.

CM105

CM106

CM936

CM937(NS)

CM940

CM941A(NS)

CM941(NS)

CM127

CM126

PAGE 47

CM93

CM100

WM1075

CM101

CM204

CM205

CM206

S4S - 13 Sizes

FLEX JAM496 & 696

We have many more profiles available that may suit your specific design requirements. We are always available to recreate your custom patterns at...

**1-888-883-3113**

Miami, FL 33166

1-888-883-3113

FAX 1-305-675-3738







**BILL TO**

NAME \_\_\_\_\_  
 COMPANY \_\_\_\_\_  
 ADDRESS \_\_\_\_\_  
 \_\_\_\_\_  
 \_\_\_\_\_  
 CITY \_\_\_\_\_  
 STATE \_\_\_\_\_  
 PHONE \_\_\_\_\_  
 PO# \_\_\_\_\_

**SHIP TO**

NAME \_\_\_\_\_  
 COMPANY \_\_\_\_\_  
 ADDRESS \_\_\_\_\_  
 \_\_\_\_\_  
 \_\_\_\_\_  
 CITY \_\_\_\_\_  
 STATE \_\_\_\_\_  
 PHONE \_\_\_\_\_  
 PO# \_\_\_\_\_

SHIP BY :     GROUND     NEXT DAY AIR

AIR DELIVERY IS ADDED TO INVOICE. AUTHORIZATION REQUIRED.

Signature: \_\_\_\_\_

HALF ROUND	QTY	PROFILE	DIAMETER
<p>RADIUS 1/2 DIAMETER</p> <p>( )</p> <p>DIAMETER INSIDE JAMB WIDTH</p>			

ARCS OR EYEBROWS	QTY	PROFILE	WIDTH	RISE
<p>( )</p> <p>RISE</p> <p>WIDTH</p> <p>( )</p>				

ELLIPSES & OVALS	QTY	PROFILE	DIMENSIONS	WINDOW/DOOR MFGR.	MODEL #
<p>TEMPLATE REQUIRED</p> <p>(WE HAVE SOME TEMPLATES)</p>					

STRAIGHT LENGTH FLEXIBLE MOULDING	QTY	PROFILE	*LENGTH
Straight lengths have application limitations. Please call to determine the best solution for your requirements.			

\*SEE PRICE LIST FOR STOCK ITEM SIZES.

